

Multi Profile Router

Multi Profile Router Gives You A Wide Range Of Profiling Options in a Single Router Bit With Replaceable Carbide Tips.

Durability: Replaceable blades are harder, stronger, longer lasting and offer better performance with abrasive materials.

Versatility: One tool gives you a wide range of profiling options, that can be used with portable or industrial CNC machinery.

Safety: Designed for chip limitation with additional protective shield.

Service-Free: The tool does not need sharpening, providing: consistent profiles with no loss of work time.

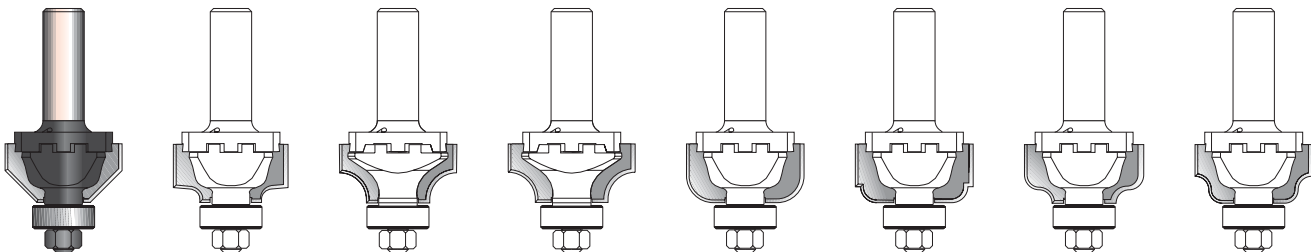



Multi Profile Router

Patent Pending #129720



Router Body Options:

- Type A with ball bearing
- Type B without ball bearing

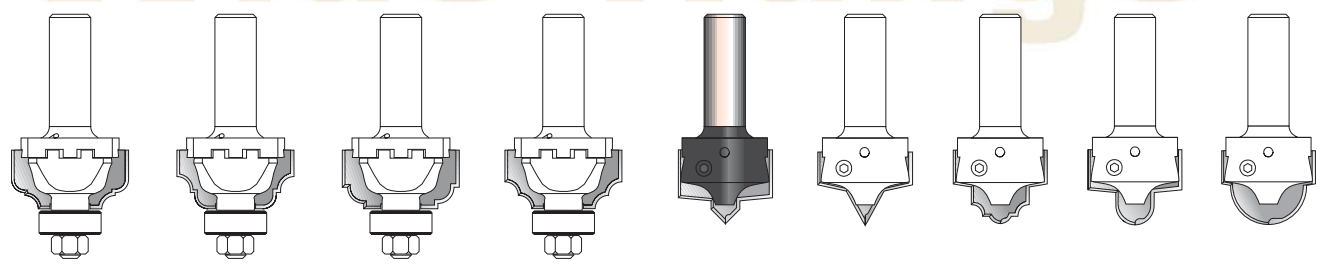

Index



Sawing

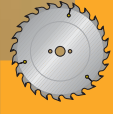

CNC

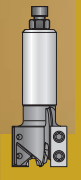

Cutting



Drilling

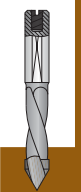

Routing

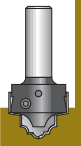

Custom Tooling

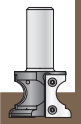



Routing

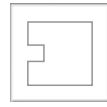

Grooving & Sizing

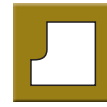

Profiling & Chamfering

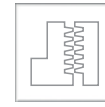

Jointing & Rebating



Carving

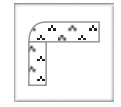

Corian

Index

Multi Profile Router

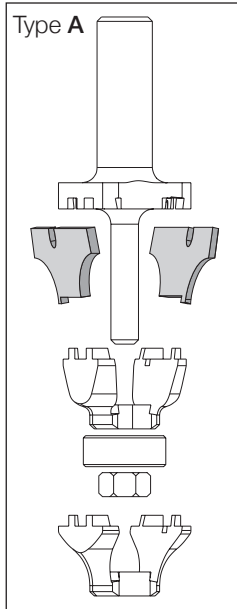

Type	D	Code No.	L	ød
A	34	808 101 9	75	12
	34	808 101 5	69	8
	34	808 101 3	69	6
B	28	808 001 9	59	12
	28	808 001 5	53	8
	28	808 001 3	53	6

⚠ 6mm shank can be supplied with 1/4" shank.
12mm shank can be supplied with 1/2" shank.

Each replaceable carbide tip and its safety shield have identical markings to ensure correct use of shield only with its corresponding carbide tip.

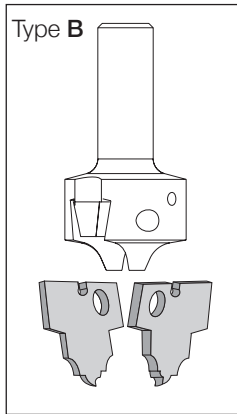

T.C. Blade for Multi Profile Router Type A

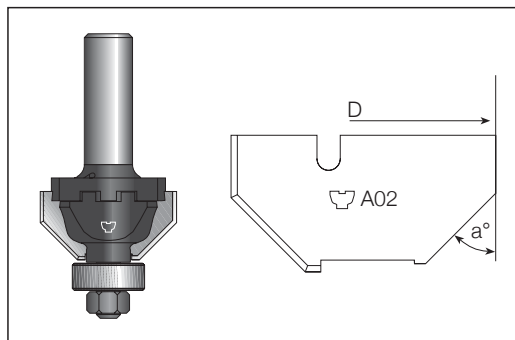

	Code No.	øD	a°
A01	351 180 5	35.0	30°
A02	351 181 0	38.0	45°

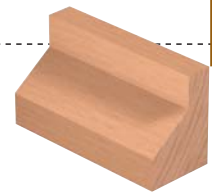

Sawing



CNC



Cutting

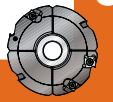

Drilling

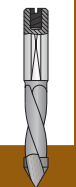

Routing

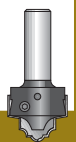

Custom Tooling

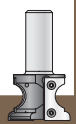



Routing



Grooving & Sizing



Profiling & Chamfering

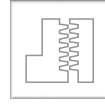

Jointing & Rebating

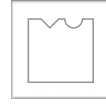

Carving

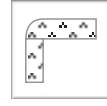

Corian



T.C. Blade for Multi Profile Router Type A

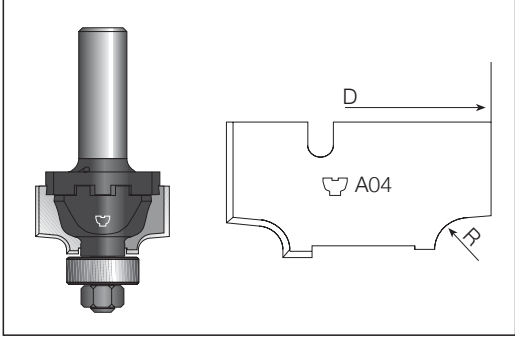

	Code No.	øD	R
A03	351 090 5	35.0	3.2
A04	351 091 0	35.0	4.8

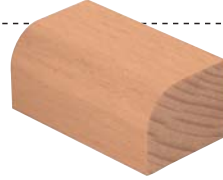

Sawing

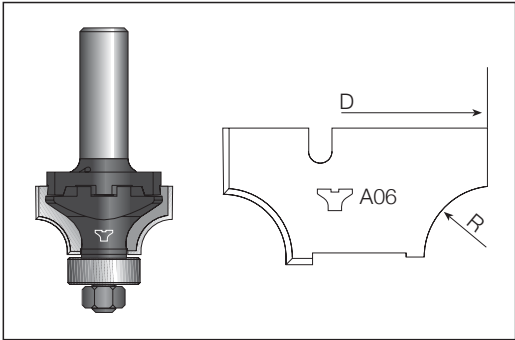

	Code No.	øD	R
A05	351 091 5	35.0	6.35
A06	351 092 0	35.0	7.9
A07	351 092 5	38.0	9.5

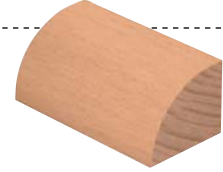

CNC

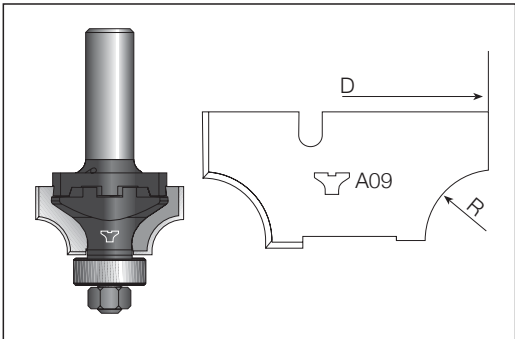
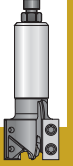

	Code No.	øD	R
A08	351 190 5	35.0	4.8
A09	351 191 0	35.0	6.35
A10	351 191 5	38.0	7.9

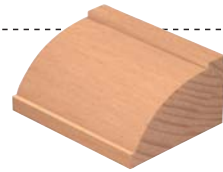

Drilling

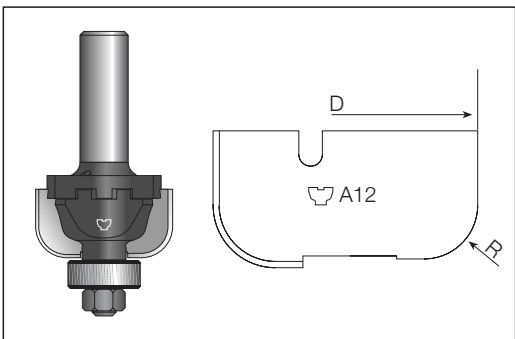
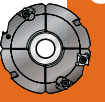

	Code No.	øD	R
A11	351 120 5	35.0	6.3
A12	351 121 0	35.0	7.9
A13	351 121 5	38.0	9.5

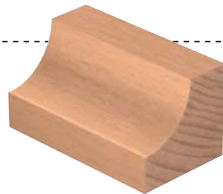

Routing

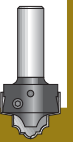

Custom Tooling

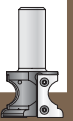



Routing



Grooving & Sizing



Profiling & Chamfering

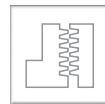

Jointing & Rebating

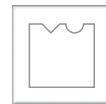

Carving

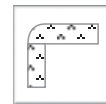

Corian

Index

T.C. Blade for Multi Profile Router Type A

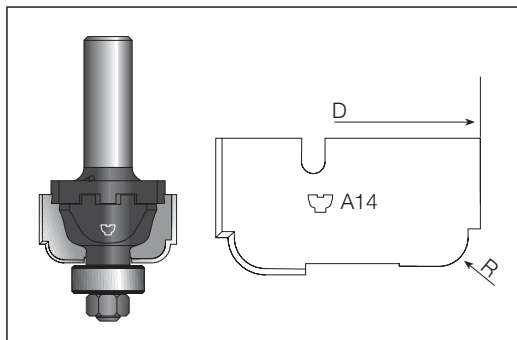

	Code No.	øD	R
A14	351 40 05	35.0	4.8

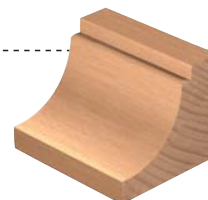

Sawing

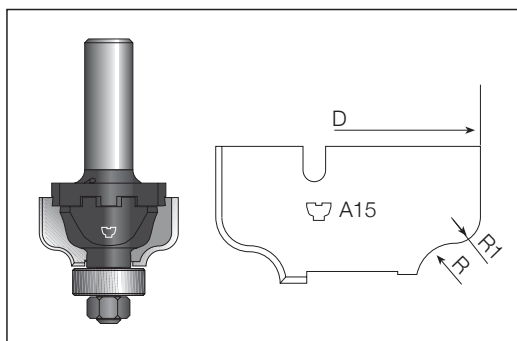

	Code No.	øD	R	R1
A15	351 38 05	36.0	4.0	4.5
A16	351 38 10	38.0	4.0	4.5

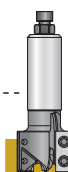
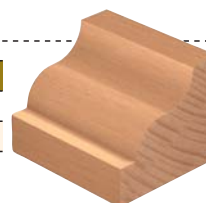

CNC

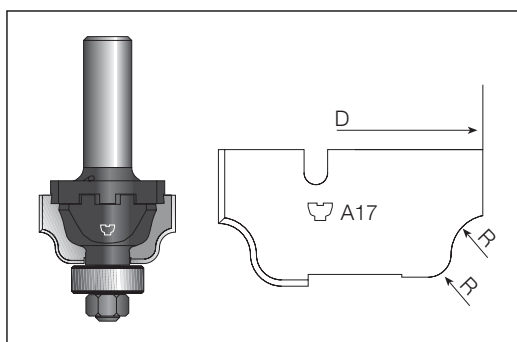

	Code No.	øD	R
A17	351 130 5	35.0	4.0/4.0

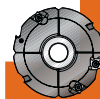
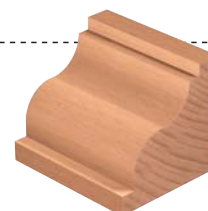

Cutting

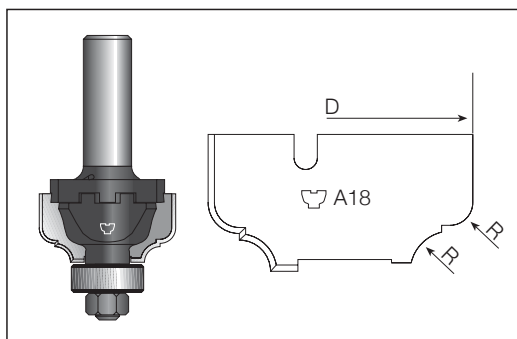

	Code No.	øD	R
A18	351 350 5	35.0	4.0/4.0
A19	351 351 0	38.0	4.0/4.0

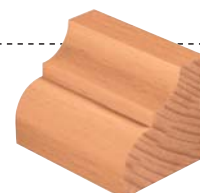

Routing

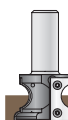

Custom Tooling



Routing



Grooving & Sizing

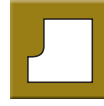

Profiling & Chamfering

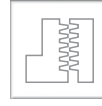

Jointing & Rebating



Carving

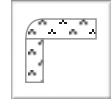

Corian



T.C. Blade for Multi Profile Router Type A

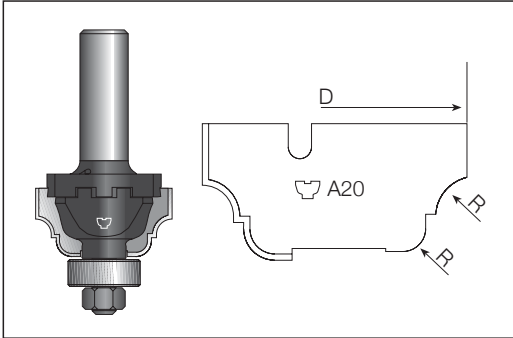

	Code No.	øD	R
A20	351 340 5	38.0	4.0/4.0

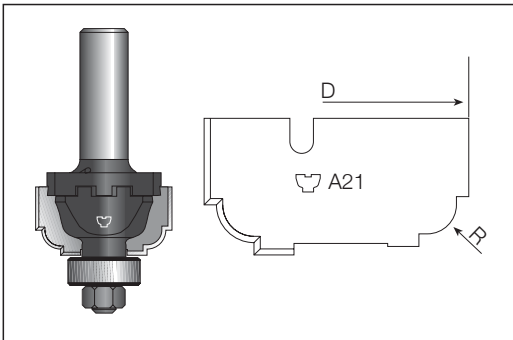
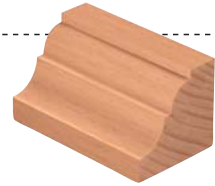

	Code No.	øD	R
A21	351 390 5	35.0	4.8

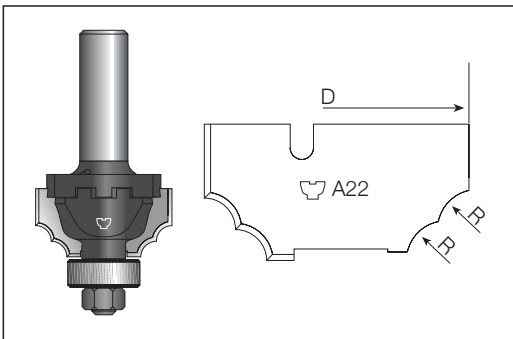
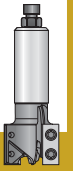
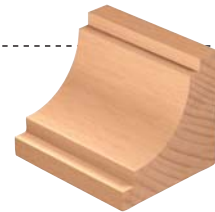

	Code No.	øD	R
A22	351 360 5	35.0	4.0/4.0
A23	351 361 0	38.0	4.0/4.0

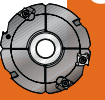
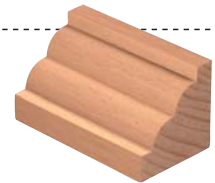

T.C. Blade for Multi Profile Router Type B

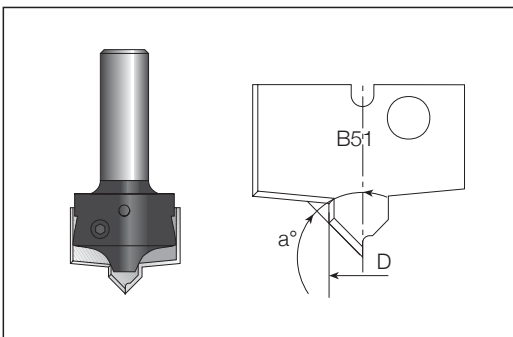

	Code No.	øD	a°
B51	351 051 0	9.5	45°

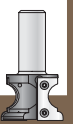
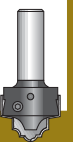



Routing

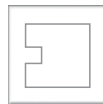

Grooving & Sizing



Profiling & Chamfering

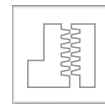

Jointing & Rebating



Carving



Corian

Index

T.C. Blade for Multi Profile Router Type B

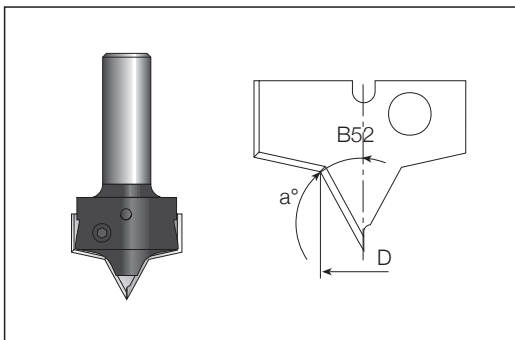

	Code No.	øD	a°
B52	351 050 5	12.7	30°

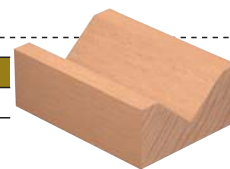

Sawing

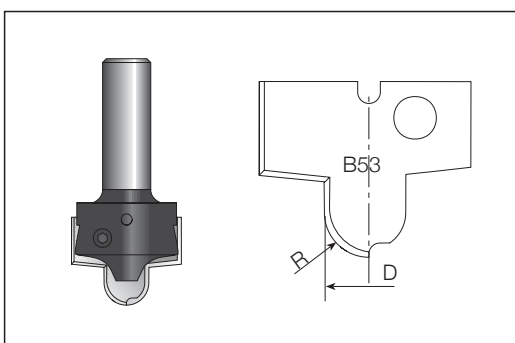

	Code No.	øD	R
B53	351 060 5	12.7	6.35

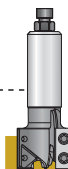
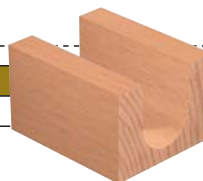

CNC

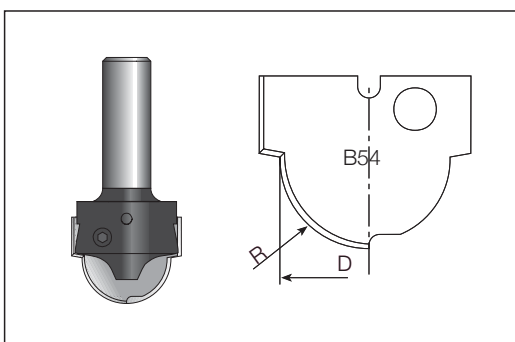

	Code No.	øD	R
B54	351 061 0	25.4	12.7

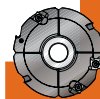

Drilling

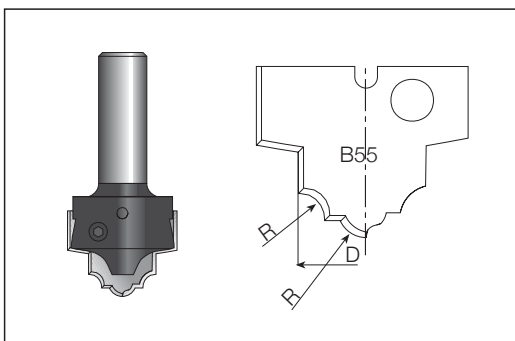

	Code No.	øD	R
B55	351 310 5	19.1	4.0/4.0

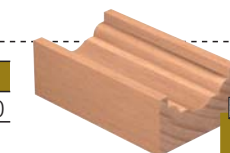

Routing



Custom Tooling



Routing

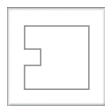

Grooving & Sizing



Profiling & Chamfering

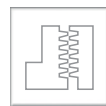

Jointing & Rebating

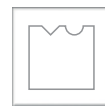

Carving

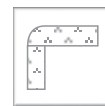

Corian

Bevel Bit

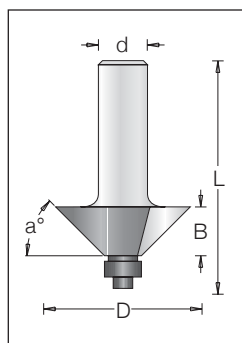

øD	a	B	Code No.	L	ød	
31.8	45°	12.7	1180 01 3	51.0	6	A
	45°	12.7	1180 01 5	54.5	8	A
	45°	12.7	1180 01 9	60.0	12	A
50.0	45°	19.1	1180 04 9	69.0	12	B
60.5	45°	25.4	1180 07 9	74.0	12	B
34.9	60°	20.6	1181 00 3	61.0	6	B
	60°	20.6	1181 00 9	71.0	12	B
76.2	45°	25.4	1180 09 9	90.0	12	C

⚠ 6mm shank can be supplied with 1/4" shank.
12mm shank can be supplied with 1/2" shank.

Spare Parts:



A. Ball Bearing
#191 001 0
9.5x3.2x4



B. Ball Bearing
#191 007 0
12.7x4.7x5



C. Ball Bearing
#191 972 0
25.4x6.3x9.1

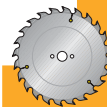
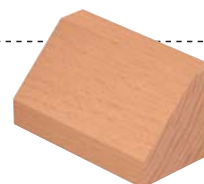

Sawing



CNC

Adjustable Trimmer

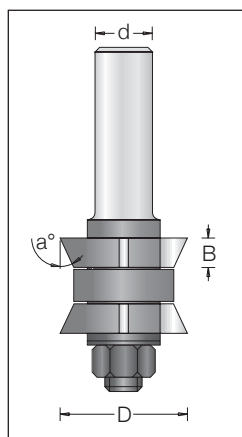

øD	a	Code No.	L	ød
22.0	0°	1161 01 9 (1 cutter)	76	12
25.4	15°	1161 04 9 (1 cutter)	76	12
27.0	25°	1160 27 9 (2 cutters) *	96	12
	25°	1161 07 9 (1 cutter)	76	12
34.0	45°	1160 21 9 (2 cutters) *	96	12
	45°	1161 20 9 (1 cutter)	76	12

⚠ Can be supplied with 1/2" shank.

Spare Parts:



Arbor & Nut
#190 004 9
L=76



Arbor & Nut *
#190 009 9
L=96



Ball Bearing
#191 013 0
8x22x7

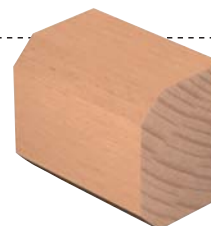

Cutting



Drilling

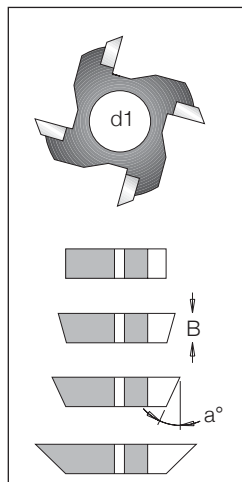

øD	a	B	Cutter No.	ød1
22.0	0°	6.5	1160 01 0	7.94
25.4	15°	6.5	1160 04 0	7.94
	25°	6.5	1160 07 0	7.94
27.0	25°	6.5	1160 17 0	7.94
	25°	6.5	1160 17 0	7.94
34.0	45°	6.5	1160 20 0	7.94
34.0	45°	6.5	1160 21 0	7.94



Routing

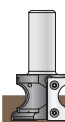

Custom Tooling

Routing



Grooving & Sizing



Profiling & Chamfering

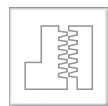

Jointing & Rebating



Carving

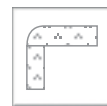

Corian



Bevel Trimmer Bit

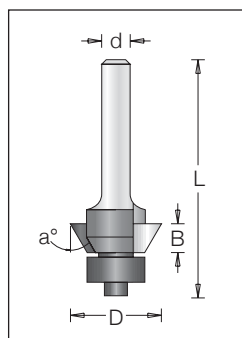

øD	a	B	Code No.	L	ød
12.7	0°	6.3	1020 01 3	53	6
	0°	6.3	1020 01 5	53	8
15.9	15°	6.3	1020 04 3	53	6
	15°	6.3	1020 04 5	53	8
19.1	25°	6.3	1020 07 3	53	6
	25°	6.3	1020 07 5	53	8
	30°	6.3	1020 08 3	53	6
	30°	6.3	1020 08 5	53	8

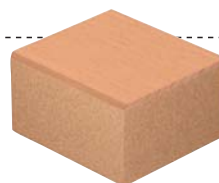

⚠ Can be supplied with 1/4" shank.

Spare Parts:



Ball Bearing
#191 007 0
12.7x4.7x5

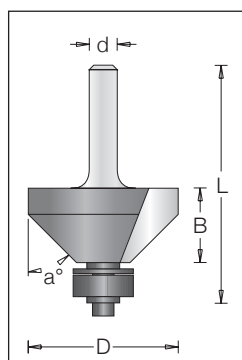
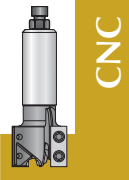

øD	a	B	Code No.	L	ød	
22.2	45°	6.3	1020 10 3	47.0	6	A
	45°	6.3	1020 10 5	50.0	8	A
24.0	15°	9.5	1020 05 3	53.0	6	A
	15°	9.5	1020 05 5	56.5	8	A
35.0	45°	18.0	1020 12 3	57.0	6	B
	45°	18.0	1020 12 9	67.0	12	B



⚠ 6mm shank can be supplied with 1/4" shank.
12mm shank can be supplied with 1/2" shank.

Spare Parts:



A. Ball Bearing
#191 014 0
19x6.3x7



B. Ball Bearing
#191 007 0
12.7x4.7x5

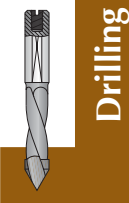
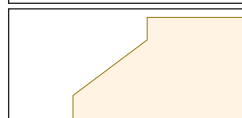

Bevel Trimmer Bit Three Fluted

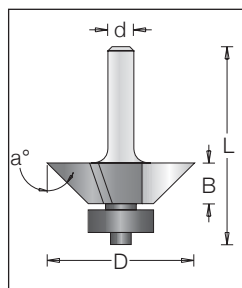

øD	a	B	Code No.	L	ød
17.5	10°	10	1410 01 3	49	6
	15°	10	1410 04 3	49	6
19.0	15°	10	1410 04 5	53	8
	25°	10	1410 07 3	50	6
22.2	25°	10	1410 07 5	53	8
	45°	10	1410 10 3	50	6
30.0	45°	10	1410 10 5	53	8



⚠ Can be supplied with 1/4" shank.

Spare Parts:



Ball Bearing
#191 010 0
5x16x5

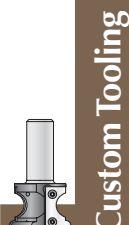
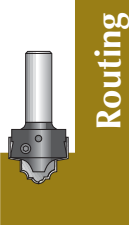



Routing

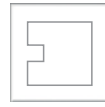

Grooving & Sizing

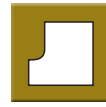

Profiling & Chamfering

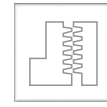

Jointing & Rebating



Carving

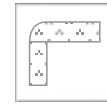

Corian

Bevel Trimming Bit

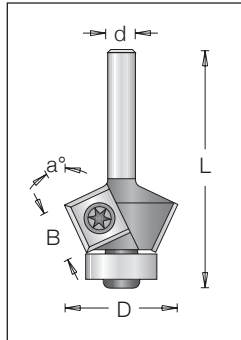

øD	a	B	Code No.	L	ød
20	15°	12	1021 52 3	55	6
	15°	12	1021 52 5	55	8
24	25°	12	1022 52 3	55	6
	25°	12	1022 52 5	55	8
26	30°	12	1023 02 3	54	6
	30°	12	1023 02 5	54	8

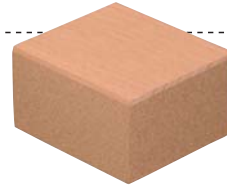

⚠ Can be supplied with 1/4" shank.

Spare Parts:



T.C. Blade
#310 121 2
12x12x1.5



Torx screw
#193 148 2
M4x5.6



Ball Bearing
#191 005 0
16x6.3x4.7



Torx key
#194 101 5
T15

Bevel Trimming Bit

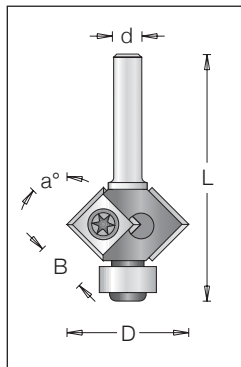

øD	a	B	Code No.	L	ød
27	45°	12	1024 52 3	56	6
	45°	12	1024 52 5	58	8

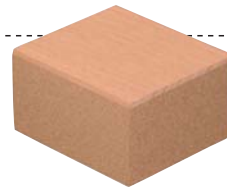

⚠ Can be supplied with 1/4" shank.

Spare Parts:



T.C. Blade
310 121 2
12x12x1.5



Torx screw
193 148 2
M4x5.6



Ball Bearing
191 003 0
6.3x12.7x4.7



Torx key
194 101 5
T15

Chamfering 45°
With Ball Bearing
Guide

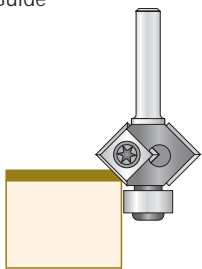

Application "v" groove. By putting different ball bearings, you can adjust the groove depth as follows:

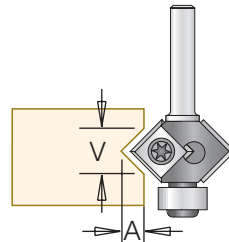

Code No.	Description	A	V
191 003 0	1/4" x 1/2" x 3/16"	7.0mm	14.0mm
191 005 0	1/4" x 5/8" x 3/16"	5.0mm	10.0mm
191 014 0	1/4" x 3/4" x 9/32"	3.2mm	6.4mm
191 937 0	1/4" x 27 x 5		

45° miter joint undercutter assembly
with delrin guide

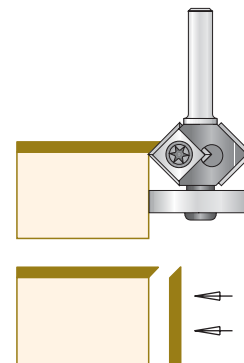

Routing

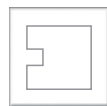

Grooving & Sizing



Profiling & Chamfering

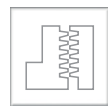

Jointing & Rebating



Carving



Corian



Core Box Bit

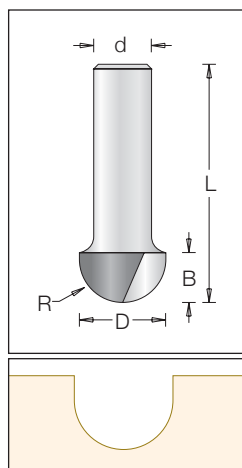

øD	R	B	Code No.	L	ød
9.5	4.8	6.3	1060 09 3	38.0	6
	4.8	6.3	1060 09 5	42.5	8
12.7	6.3	9.5	1060 12 3	38.0	6
	6.3	9.5	1060 12 5	41.5	8
15.9	7.9	11.0	1060 15 3	40.0	6
	7.9	11.0	1060 15 5	43.5	8
19.1	9.5	11.0	1060 18 3	40.0	6
	9.5	11.0	1060 18 5	43.0	8
22.2	11.0	13.8	1060 21 3	44.5	6
	11.0	13.8	1060 21 5	46.0	8
25.4	12.7	17.5	1060 24 3	46.5	6
	12.7	17.5	1060 24 5	50.0	8
9.5	4.8	6.3	1060 09 9	52.0	12
12.7	6.3	9.5	1060 12 9	55.5	12
15.9	7.9	11.0	1060 15 9	51.0	12
19.1	9.5	11.0	1060 18 9	49.5	12
22.2	11.0	13.8	1060 21 9	52.0	12
25.4	12.7	17.5	1060 24 9	56.0	12
32.0	16.0	32.0	1060 33 9	70.0	12
38.1	19.1	32.0	1060 37 9	70.0	12
50.8	25.4	32.0	1060 40 9	70.0	12

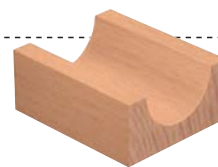

⚠ 6mm shank can be supplied with 1/4" shank.
12mm shank can be supplied with 1/2" shank.

Core Box Bit

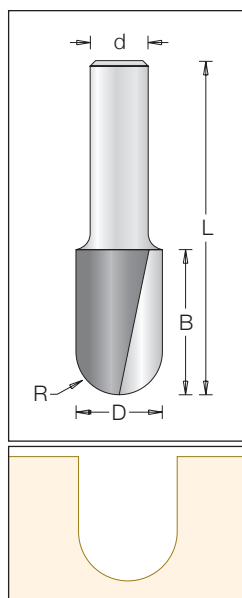

øD	R	B	Code No.	L	ød
3.2	1.6	9.5	1060 01 3 *	44.0	6
	1.6	9.5	1060 01 5 *	44.0	8
4.8	2.4	11.0	1060 03 3 *	47.0	6
	2.4	11.0	1060 03 5 *	47.0	8
6.3	3.2	11.0	1060 06 3 *	47.0	6
	3.2	11.0	1060 06 5 *	47.0	8
8.0	4.0	12.7	1060 07 3	47.0	6
	4.0	12.7	1060 07 5	50.0	8
14.0	7.0	18.0	1060 17 3	46.5	6
	7.0	18.0	1060 17 5	50.0	8
	7.0	18.0	1060 17 9	60.0	12
18.0	9.0	19.0	1060 20 3	48.0	6
	9.0	19.0	1060 20 5	51.0	8
9.5	4.8	25.4	1060 11 5	58.0	8
	4.8	25.4	1060 11 9	70.0	12
12.7	6.3	32.0	1060 13 9	73.0	12
14.2	7.1	32.0	1060 14 9	73.0	12
16.0	8.0	32.0	1060 16 9	70.0	12
19.1	9.5	32.0	1060 19 9	70.0	12
22.2	11.1	32.0	1060 29 9	70.0	12
25.4	12.7	32.0	1060 30 9	70.0	12

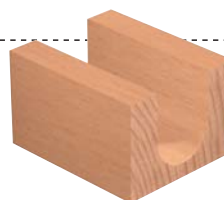

⚠ *Solid Carbide
6mm shank can be supplied with 1/4" shank.
12mm shank can be supplied with 1/2" shank.



Sawing



CNC

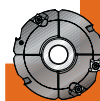

Cutting



Drilling



Routing

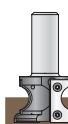

Custom Tooling



Routing



Grooving & Sizing



Profiling & Chamfering

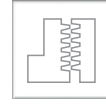

Jointing & Rebating



Carving

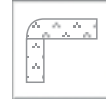

Corian



Index

Dish Carving Bit

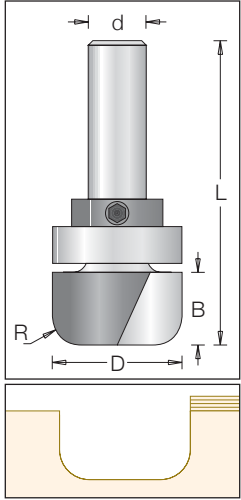

øD	R	B	Code No.	L	ød	
12.7	3.0	12.7	1062 62 3	54	6	A
19.1	6.5	16.0	1062 63 3	60	6	B
	6.5	16.0	1062 63 9	67	12	C
28.6	6.5	16.0	1062 69 9	67	12	D

⚠ 6mm shank can be supplied with 1/4" shank.
12mm shank can be supplied with 1/2" shank.

Spare Parts:



A. Ball Bearing
#191 003 0
1/4 x 1/2 x 3/16



B. Ball Bearing
#191 014 0
1/4 x 3/4 x 9/32



C. Ball Bearing
#191 020 0
1/2 x 3/4 x 5/32



D. Ball Bearing
#191 018 0
1/2 x 11/8 x 12

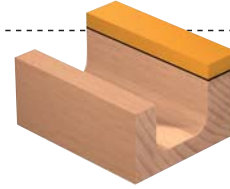

Sawing

Dish Carving Bit

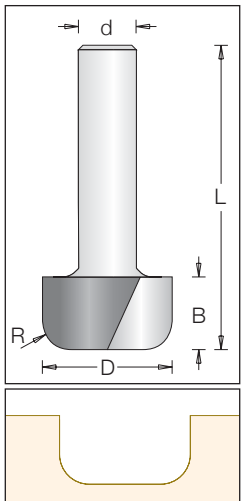

øD	R	B	Code No.	L	ød
11.0	3.0	12.7	1060 60 3	54	6
12.7	3.0	12.7	1060 62 3	54	6
19.1	6.5	16.0	1060 63 3	60	6
	6.5	16.0	1060 63 9	67	12
28.6	6.5	16.0	1060 69 9	67	12

⚠ 6mm shank can be supplied with 1/4" shank.
12mm shank can be supplied with 1/2" shank.

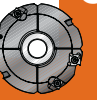
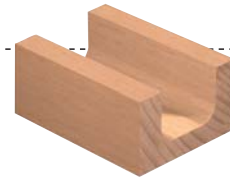

Cutting

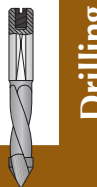

Drilling



Routing



Custom Tooling

Routing



Grooving & Sizing

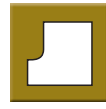

Profiling & Chamfering

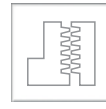

Jointing & Rebating

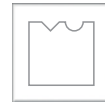

Carving

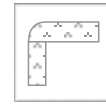

Corian



Rounding Over Bit

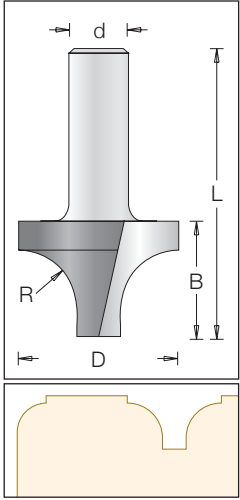

øD	R	B	Code No.	L	ød
19.1	6.3	12.7	1170 01 3	41.0	6
	6.3	12.7	1170 01 5	44.5	8
22.2	7.9	14.3	1170 04 3	43.0	6
	7.9	14.3	1170 04 5	46.5	8
25.4	9.5	15.9	1170 07 3	44.0	6
	9.5	15.9	1170 07 5	47.5	8
15.9	4.8	11.1	1170 03 9	49.0	12
19.1	6.3	12.7	1170 01 9	51.0	12
22.2	7.9	14.3	1170 04 9	52.5	12
25.4	9.5	15.9	1170 07 9	54.0	12
34.9	12.7	25.4	1170 10 5	57.5	8
	12.7	25.4	1170 10 9	63.5	12
44.5	15.9	31.8	1170 13 5	63.5	8
	15.9	31.8	1170 13 9	70.0	12
50.8	19.1	36.5	1170 17 9	75.0	12

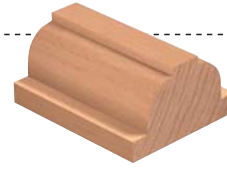

⚠ 6mm shank can be supplied with 1/4" shank.
12mm shank can be supplied with 1/2" shank.

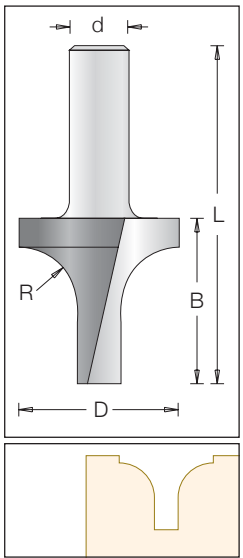

øD	øD1	R	B	Code No.	L	ød
22	12	3	31	117 150 5	63	8
	12	3	31	117 150 9	69	12
30	12	6	35	117 155 5	67	8
	12	6	35	117 155 9	73	12
34	12	8	38	117 160 5	70	8
	12	8	38	117 160 9	76	12



⚠ Can be supplied with 1/2" shank.

Core Box Bit

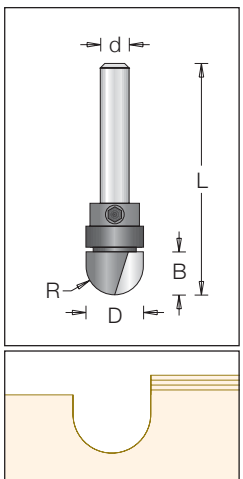

øD	R	B	Code No.	L	ød
12.7	6.35	9.5	1062 12 3	51	6

⚠ Can be supplied with 1/4" shank.

Spare Parts:



Ball Bearing
#191 003 0
6.3 x 12.7 x 4.7

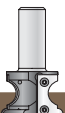
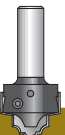
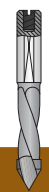
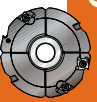
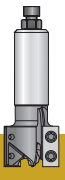
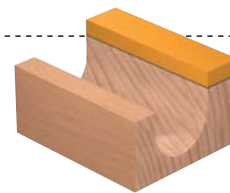



Routing

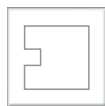

Grooving & Sizing



Profiling & Chamfering

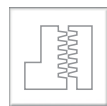

Jointing & Rebating

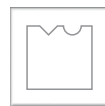

Carving

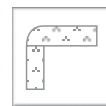

Corian



Index

Ogee Bit

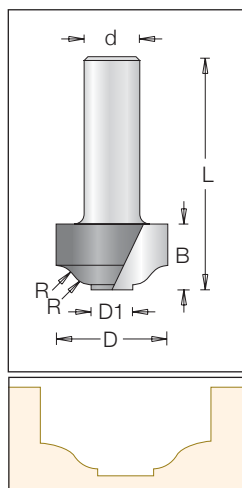

øD	øD1	R	B	Code No.	L	ød
25.4	9.5	4.8	15.1	1473 05 9	53.2	12
30.2	11.9	5.9	15.1	1473 10 9	53.2	12

⚠ Can be supplied with 1/2" shank.

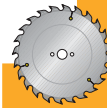
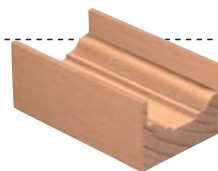

Sawing

Round & Ogee Bit

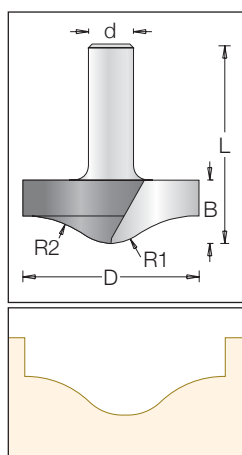

øD	R1	R2	B	Code No.	L	ød
41.5	9.5	19	18	1373 02 9	56	12
50.0	16.0	30	18	1373 06 9	56	12

⚠ Can be supplied with 1/2" shank.

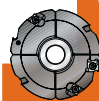
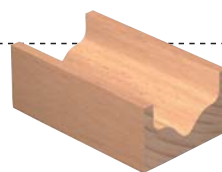

CNC

Cutting

Round & Ogee Bit

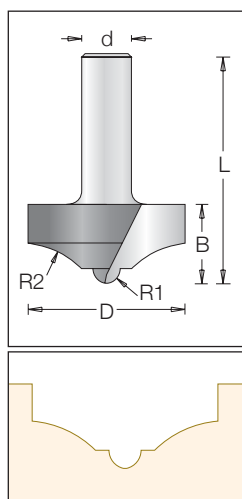

øD	R1	R2	B	Code No.	L	ød
40	4	22	20	1373 04 9	58	12

⚠ Can be supplied with 1/2" shank.

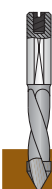
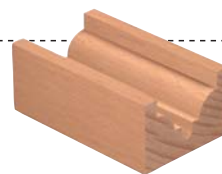

Drilling

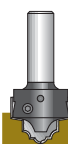

Routing

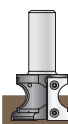

Custom Tooling

Routing

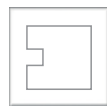

Grooving & Sizing



Profiling & Chamfering

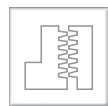

Jointing & Rebating



Carving



Corian



Beading Bit

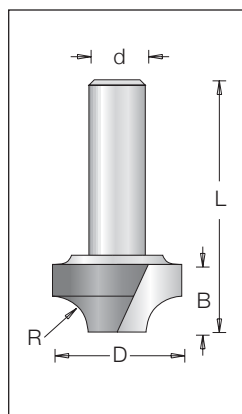

øD	R	B	Code No.	L	ød
9.8	2.5	9	1270 01 3	49	6
	2.5	9	1270 01 5	49	8
12.7	3.0	10	1270 02 3	48	6
19.1	3.0	10	1270 04 3	51	6
20.0	4.0	9	1270 05 3	38	6
	4.0	9	1270 05 5	41	8
22.0	5.0	12	1270 06 3	55	6
	5.0	12	1270 06 5	44	8
24.0	6.0	11	1270 07 5	43	8
	7.0	12	1270 10 3	41	6
26.0	7.0	12	1270 10 5	44	8
	8.0	14	1270 08 3	58	6
28.6	8.0	14	1270 08 5	46	8
	8.0	14	1270 08 9	68	12



⚠ 6mm shank can be supplied with 1/4" shank.
12mm shank can be supplied with 1/2" shank.

Beading Bit

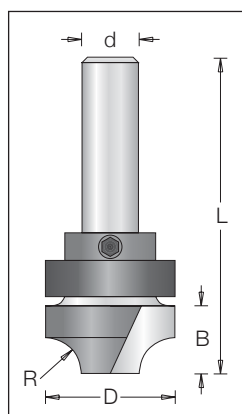

øD	R	B	Code No.	L	ød	
12.7	3	10	1272 02 3	48	6	A
19.1	3	10	1272 04 3	51	6	B
22.0	5	12	1272 06 3	55	6	C
	5	12	1272 06 5	58	8	C
28.6	8	14	1272 08 3	58	6	D
	8	14	1272 08 5	62	8	D
	8	14	1272 08 9	68	12	D

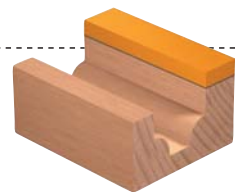

⚠ 6mm shank can be supplied with 1/4" shank.
12mm shank can be supplied with 1/2" shank.

Spare Parts:



A. Ball Bearing
#191 003 0
12.7x6.3x4.7



B. Ball Bearing
#191 014 0
19x6.3x7



C. Ball Bearing
#191 013 0
22x8x7



D. Ball Bearing
#1910180
28.5x12.7x7.93

Traditional Bit

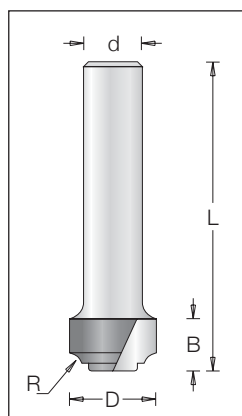

øD	R	B	Code No.	L	ød
12.7	2.0	10.5	1280 01 5	52	8
19.1	3.5	11.1	1280 04 5	52	8
	3.5	11.1	1280 04 9	68	12

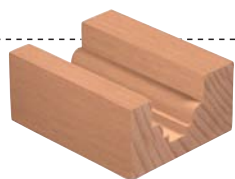

⚠ 12mm can be supplied with 1/2" shank.



Routing



Grooving & Sizing



Profiling & Chamfering

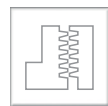

Jointing & Rebating

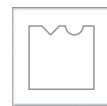

Carving

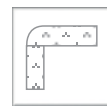

Corian



Index

Round Over Bit

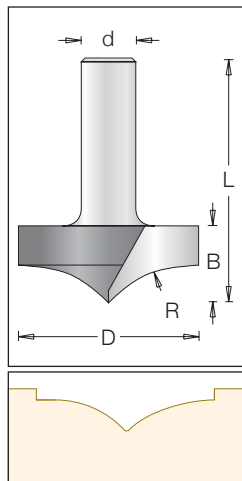

øD	R	B	Code No.	L	ød
44.5	18.3	18.3	1173 02 9	56.3	12
41.3	25.4	18.3	1173 04 9	56.3	12

⚠ Can be supplied with 1/2" shank.

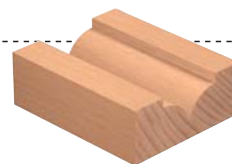

Sawing

Ogee Bit - Flat Bottom

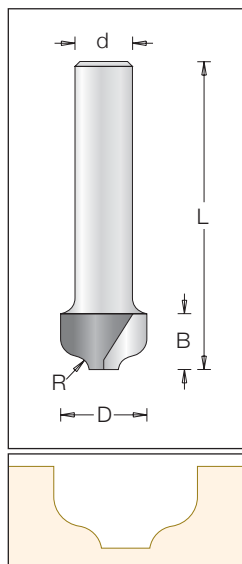

øD	R	B	Code No.	L	ød
12.7	2.0	9.5	1300 04 3	51	6
	2.0	9.5	1300 04 5	51	8
	3.5	12.7	1300 07 3	53	6
19.1	3.5	12.7	1300 07 5	53	8
	3.5	12.7	1300 07 9	68	12

⚠ 6mm shank can be supplied with 1/4" shank.
12mm shank can be supplied with 1/2" shank.

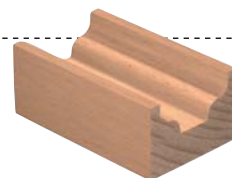

CNC

Classical Bit

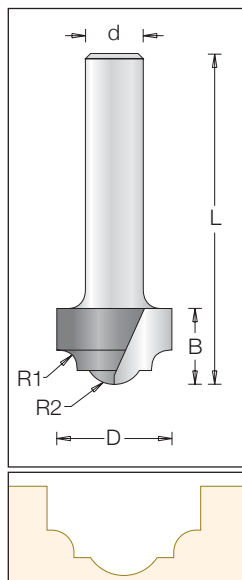

øD	R1	R2	B	Code No.	L	ød
12.7	2.5	3.5	10.5	1310 01 3	51	6
	2.5	3.5	10.5	1310 01 5	51	8
	3.7	4.0	12.7	1310 04 3	54	6
19.1	3.7	4.0	12.7	1310 04 5	54	8
	3.7	4.0	12.7	1310 04 9	70	12
25.4	5.0	6.3	16.5	1310 07 5	57	8
	5.0	6.3	16.5	1310 07 9	73	12
38.1	6.3	6.3	19.1	1310 09 9	76	12

⚠ 6mm shank can be supplied with 1/4" shank.
12mm shank can be supplied with 1/2" shank.



Drilling



Routing

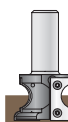

Custom Tooling

Routing



Grooving & Sizing



Profiling & Chamfering

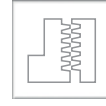

Jointing & Rebating



Carving

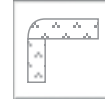

Corian



Index



Paneling Groover

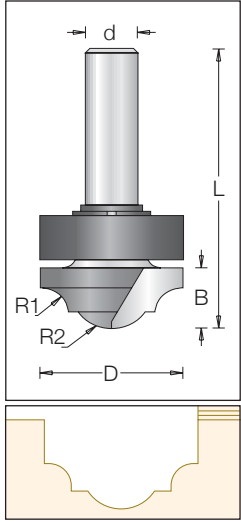

øD	R1	R2	Code No.	B	L	ød	
22	4.0	5.5	1312 05 3	12	52	6	A
	4.0	5.5	1312 05 5	12	55	8	A
35	6.5	10.0	1312 22 9	15	68	12	B

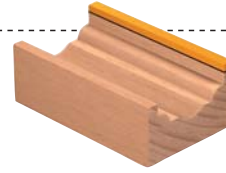

6mm shank can be supplied with 1/4" shank.
12mm shank can be supplied with 1/2" shank.

Spare Parts:

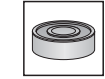

A. Ball Bearing
1910130
8x22x7



B. Ball Bearing
1910190
15x35x11

Sawing



CNC

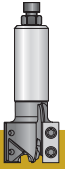

Paneling Flat Bottom Groover

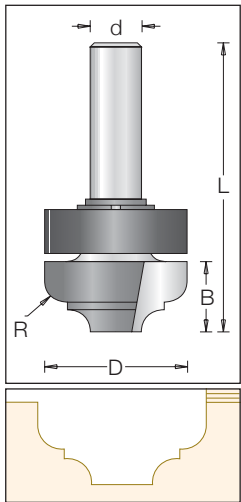

øD	R	Code No.	B	L	ød	
22	3.5	1352 05 3	11.1	51	6	A
	3.5	1352 05 5	11.1	54	8	A
35	5.0	1352 22 9	14.3	67	12	B

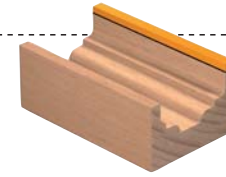

6mm shank can be supplied with 1/4" shank.
12mm shank can be supplied with 1/2" shank.

Spare Parts:

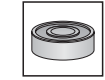

A. Ball Bearing
#191 013 0
8x22x7



B. Ball Bearing
191 019 0
15x35x11

Cutting

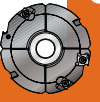

Drilling

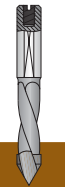

Routing



Custom Tooling

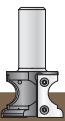



Routing

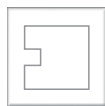

Grooving & Sizing



Profiling & Chamfering

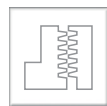

Jointing & Rebating

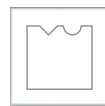

Carving

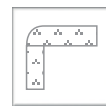

Corian



Index

Ogee Bit

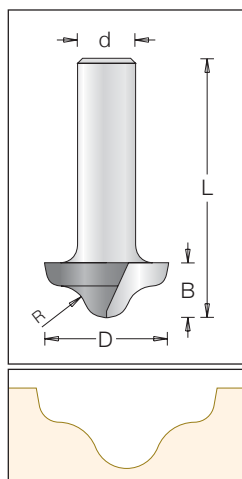

øD	R	Code No.	B	L	ød
27	6	1370 04 3	12	52	6
	6	1370 04 5	12	52	8
	6	1370 04 9	12	57	12

⚠ 6mm shank can be supplied with 1/4" shank.
12mm shank can be supplied with 1/2" shank.

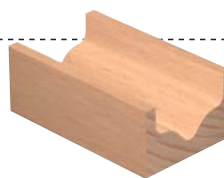

Sawing

Ogee Bit - Flat Bottom

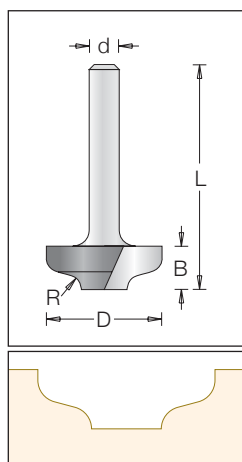

øD	R	Code No.	B	L	ød
25.4	3.2	1470 06 3	9.5	49	6
	3.2	1470 06 5	9.5	49	8
	3.2	1470 06 9	9.5	49	12
35.0	3.2	1470 10 9	9.5	59	12

⚠ 6mm can be supplied with 1/4" shank.
12mm can be supplied with 1/2" shank.

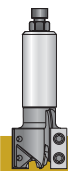
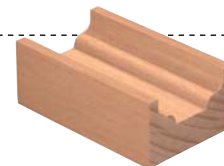

CNC

Ball Groovers

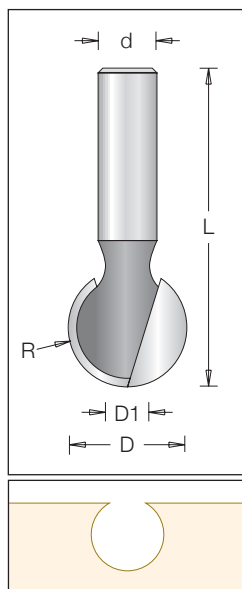

øD	øD1	R	Code No.	L	ød
12.7	6.35	6.35	1066 04 9	58	12
16.0	7.0	8.0	1066 07 9	63	12
19.0	8.0	9.5	1066 10 9	64	12
22.2	8.0	11.1	1066 13 9	68	12
25.4	8.7	12.7	1066 16 9	70	12
28.6	10.3	14.3	1066 19 9	74	12
32.0	11.1	16.0	1066 22 9	75	12

⚠ 12mm can be supplied with 1/2" shank.

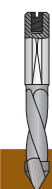
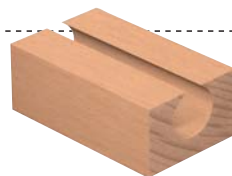

Drilling

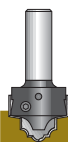

Routing

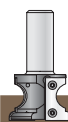

Custom Tooling

Routing



Grooving & Sizing



Profiling & Chamfering

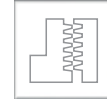

Jointing & Rebating



Carving

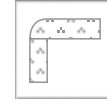

Corian



T - Slotter Bit

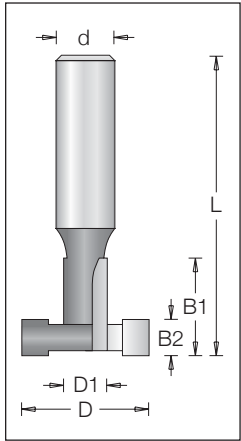

$\varnothing D$	$\varnothing D1$	Code No.	B1	B2	L	$\varnothing d$
28	9.5	1460 20 6	20.7	8.0	60	9.5
	9.5	1460 20 9	20.7	8.0	66	12.0
35	12.7	1460 23 9	22.2	9.5	65	12.0

⚠ Can be supplied with 1/2" shank.

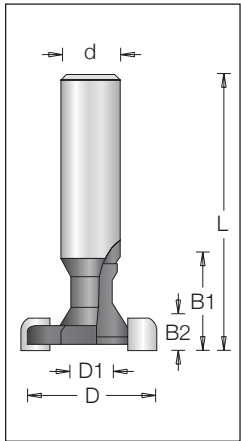
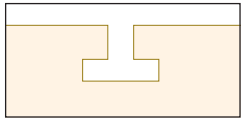
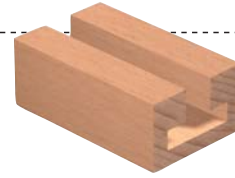

$\varnothing D$	$\varnothing D1$	Code No.	B1	B2	L	$\varnothing d$
30	10.5	1460 70 9	17	7	60	12

⚠ Can be supplied with 1/2" shank.

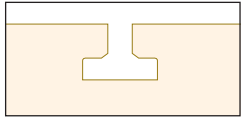

T - Slotter Radius Bit

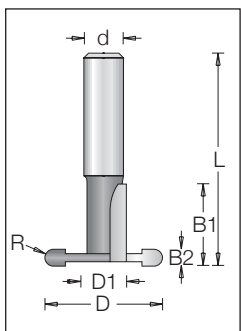

$\varnothing D$	$\varnothing D1$	Code No.	B1	B2	R	L	$\varnothing d$
40.8	9.7	1460 14 6	20.7	4	2	52	9.5
28.8	11.1	1460 10 6	20.7	4	2	52	9.5
	11.1	1460 10 9	20.7	4	2	55	12.0

⚠ Can be supplied with 1/2" shank.

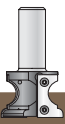
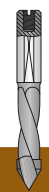
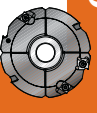
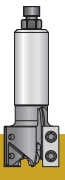
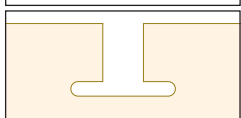
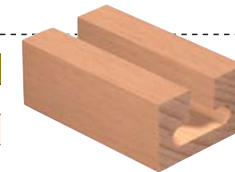



Routing

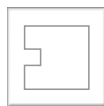

Grooving & Sizing



Profiling & Chamfering

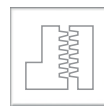

Jointing & Rebating



Carving

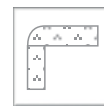

Corian

Rounding - Over Bit

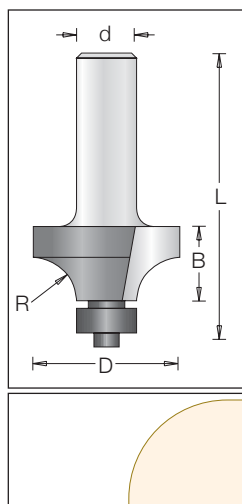

øD	R	B	Code No.	L	ød	n
15.9	1.7	7.9	1090 01 3	47.0	6	
	1.7	7.9	1090 01 5	50.0	8	
19.1	3.2	9.5	1090 04 3	50.0	6	
	3.2	9.5	1090 04 5	53.0	8	
20.7	4.0	9.5	1090 05 3	49.5	6	
	4.0	9.5	1090 05 5	53.0	8	
22.2	4.8	12.7	1090 07 3	52.0	6	
	4.8	12.7	1090 07 5	55.5	8	
25.4	6.3	12.7	1090 10 3	51.5	6	
	6.3	12.7	1090 10 5	55.0	8	
28.6	7.9	13.5	1090 13 3	53.0	6	
	7.9	13.5	1090 13 5	56.0	8	
31.8	9.5	15.9	1090 16 3	55.5	6	
	9.5	15.9	1090 16 5	59.0	8	
35.4	11.1	17.0	1090 50 3	57.0	6	
	11.1	17.0	1090 50 9	66.0	12	
38.1	12.7	19.1	1090 19 3	58.0	6	
	12.7	19.1	1090 19 5	61.0	8	
15.9	1.7	7.9	1090 01 9	57.0	12	
19.1	3.2	9.5	1090 04 9	59.0	12	
20.7	4.0	9.5	1090 05 9	59.0	12	
22.2	4.8	12.7	1090 07 9	62.0	12	
25.4	6.3	12.7	1090 10 9	62.0	12	
28.6	7.9	13.5	1090 13 9	62.0	12	
31.8	9.5	15.9	1090 16 9	65.0	12	
38.1	12.7	19.1	1090 19 9	67.0	12	
41.3	14.3	20.0	1090 20 9	70.0	12	
44.5	15.9	22.2	1090 22 9	71.0	12	
50.8	19.1	25.4	1090 25 9	75.0	12	
57.1	22.2	29.4	1090 26 9	79.0	12	
63.5	25.4	31.8	1090 28 9	91.5	12	
69.9	28.6	34.9	1090 30 9	95.0	12	18,000
76.3	31.8	38.1	1090 31 9	98.0	12	18,000
82.5	35.0	41.3	1090 33 9	101.0	12	16,000
88.9	38.1	44.5	1090 34 9	105.0	12	16,000

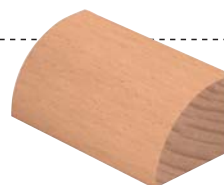

Max. RPM

⚠ 6mm shank can be supplied with 1/4" shank.
12mm shank can be supplied with 1/2" shank.

Spare Parts:



Ball Bearing
#191 007 0
12.7x4.7x5

Index

Sawing

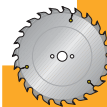

CNC



Cutting



Drilling



Routing



Custom Tooling

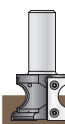

Routing

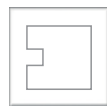

Grooving & Sizing



Profiling & Chamfering

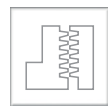

Jointing & Rebating



Carving

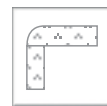

Corian



Ovolo Bit

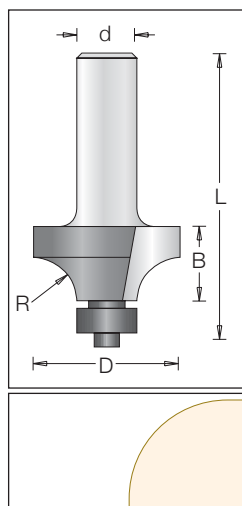

øD	R	B	Code No.	L	ød	n
16.7	2	7.7	1099 01 3	47.5	6	
	2	7.7	1099 01 5	51.0	8	
18.7	3	9.5	1099 04 3	49.5	6	
	3	9.5	1099 04 5	53.0	8	
22.7	5	12.0	1099 07 3	52.0	6	
	5	12.0	1099 07 5	55.5	8	
24.7	6	12.0	1099 10 3	51.5	6	
	6	12.0	1099 10 5	55.0	8	
28.7	8	13.5	1099 13 3	53.5	6	
	8	13.5	1099 13 5	57.0	8	
32.7	10	16.0	1099 16 3	55.5	6	
	10	16.0	1099 16 5	59.0	8	
36.7	12	17.5	1099 19 3	57.5	6	
	12	17.5	1099 19 5	61.0	8	
32.7	10	16.0	1099 16 9	65.0	12	
	12	17.5	1099 19 9	67.0	12	
42.0	15	21.2	1099 22 9	70.0	12	
48.7	18	25.7	1099 25 9	72.5	12	
52.7	20	25.4	1099 26 9	74.0	12	
62.7	25	31.2	1099 28 9	90.5	12	
72.6	30	38.7	1099 31 9	98.0	12	18,000
82.7	35	42.0	1099 33 9	91.0	12	16,000

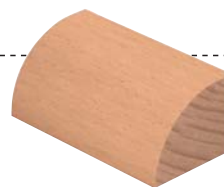

Sawing

Spare Parts:



12.7x4.7x5

⚠ 6mm shank can be supplied with 1/4" shank.
12mm shank can be supplied with 1/2" shank.

ⓘ Max. RPM

Ovolo Bit

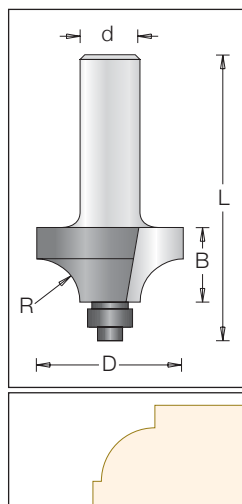

øD	R	B	Code No.	L	ød	n
16.7	2	7.7	1199 01 3	47.5	6	
	2	7.7	1199 01 5	51.0	8	
18.7	3	9.5	1199 04 3	49.5	6	
	3	9.5	1199 04 5	53.0	8	
22.7	5	12.0	1199 07 3	52.0	6	
	5	12.0	1199 07 5	55.5	8	
24.7	6	12.0	1199 10 3	51.5	6	
	6	12.0	1199 10 5	55.0	8	
28.7	8	13.5	1199 13 3	53.5	6	
	8	13.5	1199 13 5	57.0	8	
32.7	10	16.0	1199 16 3	55.5	6	
	10	16.0	1199 16 5	59.0	8	
36.7	12	17.5	1199 19 3	57.5	6	
	12	17.5	1199 19 5	61.0	8	
32.7	10	16.0	1199 16 9	65.0	12	
	12	17.5	1199 19 9	67.0	12	
42.0	15	21.2	1199 22 9	70.0	12	
48.7	18	25.7	1199 25 9	72.5	12	
52.7	20	25.4	1199 26 9	74.0	12	
62.7	25	31.2	1199 28 9	90.5	12	
72.6	30	38.7	1199 31 9	98.0	12	18,000
82.7	35	42.0	1199 33 9	91.0	12	16,000

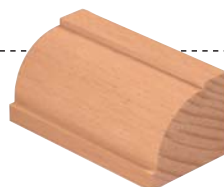

Cutting

Spare Parts:



Ball Bearing
#191 004 0
9.5x4.7x5

⚠ 6mm shank can be supplied with 1/4" shank.
12mm shank can be supplied with 1/2" shank.

ⓘ Max. RPM

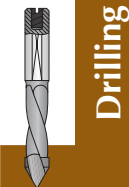

Drilling



Routing



Custom Tooling



Routing

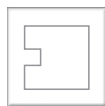

Grooving & Sizing



Profiling & Chamfering

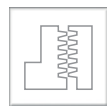

Jointing & Rebating

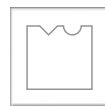

Carving

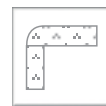

Corian



Rounding - Over Bit

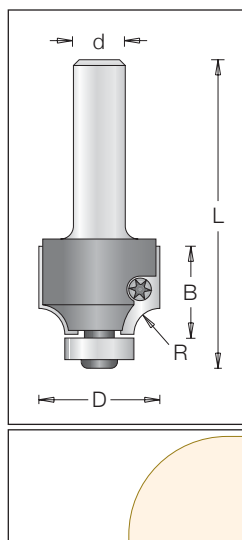

øD	R	B	Code No.	L	ød
25	3	20	1093 01 9	68	12
28	6	20	1093 02 9	68	12
32	8	30	1093 03 9	78	12
36	10	30	1093 04 9	78	12

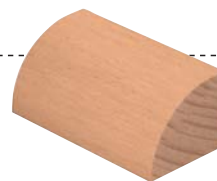

⚠ Can be supplied with 1/2" shank.

Spare Parts:



T.C. Blade
#310 930 3
R3x1.5x9x20



T.C. Blade
#310 930 6
R6x1.5x9 x20



T.C. Blade
#310 930 8
R8x1.5x15x30



T.C. Blade
#310 931 0
R10x1.5x15x30



Torx screw
#193 148 2
M4x5.6



Ball Bearing
#191 015 0
19x4.7x5



Ball Bearing
#191 010 0
5x16x5



Torx key
#194 101 5
T15

Flat Rounding - Over Bit

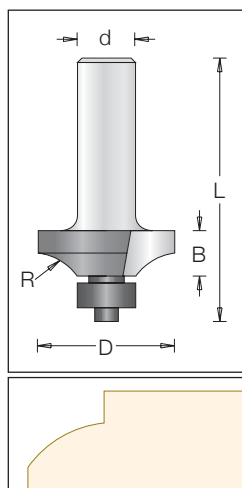

øD	R	B	Code No.	L	ød
30	12	10	1092 18 3	50.0	6
	12	10	1092 18 5	53.5	8
	12	10	1092 18 9	60.0	12

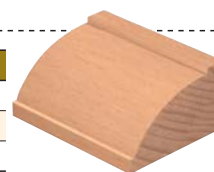

⚠ 6mm shank can be supplied with 1/4" shank.
12mm shank can be supplied with 1/2" shank.

Spare Parts:



Ball Bearing
#191 007 0
12.7x4.7x5

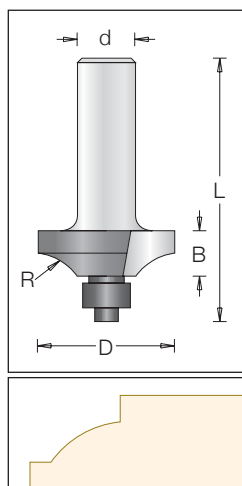

øD	R	B	Code No.	L	ød
30	12	10	1192 18 3	48.0	6
	12	10	1192 18 5	51.5	8
	12	10	1192 18 9	58.0	12

⚠ 6mm shank can be supplied with 1/4" shank.
12mm shank can be supplied with 1/2" shank.

Spare Parts:



Ball Bearing
#191 004 0
9.5x4.7x3

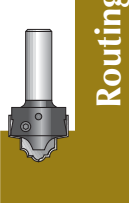
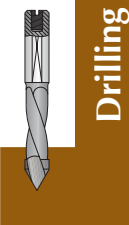
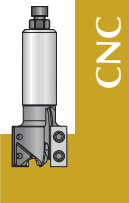

Routing

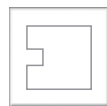

Grooving & Sizing



Profiling & Chamfering

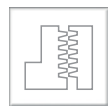

Jointing & Rebating



Carving



Corian



Ovolo Bit

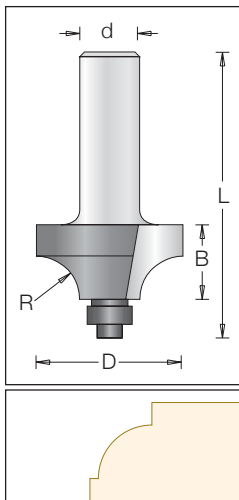

øD	R	B	Code No.	L	ød	n
15.9	1.7	7.9	1190 01 3	47.0	6	
	1.7	7.9	1190 01 5	50.0	8	
19.1	3.2	9.5	1190 04 3	50.0	6	
	3.2	9.5	1190 04 5	53.0	8	
20.7	4.0	9.5	1190 05 3	49.5	6	
	4.0	9.5	1190 05 5	53.0	8	
22.2	4.8	12.7	1190 07 3	52.0	6	
	4.8	12.7	1190 07 5	55.5	8	
25.4	6.3	12.7	1190 10 3	50.0	6	
	6.3	12.7	1190 10 5	55.0	8	
28.6	7.9	13.5	1190 13 3	53.0	6	
	7.9	13.5	1190 13 5	56.0	8	
31.8	9.5	15.9	1190 16 3	55.5	6	
	9.5	15.9	1190 16 5	59.0	8	
35.4	11.1	17.0	1190 50 3	57.0	6	
	11.1	17.0	1190 50 9	66.0	8	
38.1	12.7	19.1	1190 19 3	58.0	6	
	12.7	19.1	1190 19 5	61.0	8	
15.9	1.7	7.9	1190 01 9	57.0	12	
19.1	3.2	9.5	1190 04 9	59.0	12	
20.7	4.0	9.5	1190 05 9	59.0	12	
22.2	4.8	12.7	1190 07 9	62.0	12	
25.4	6.3	12.7	1190 10 9	62.0	12	
28.6	7.9	13.5	1190 13 9	62.0	12	
31.8	9.5	15.9	1190 16 9	65.0	12	
38.1	12.7	19.1	1190 19 9	67.0	12	
41.3	14.3	20.0	1190 20 9	70.0	12	
44.5	15.9	22.2	1190 22 9	71.0	12	
50.8	19.1	25.4	1190 25 9	75.0	12	
57.1	22.2	29.4	1190 26 9	79.0	12	
63.5	25.4	31.8	1190 28 9	91.5	12	
69.9	28.6	34.9	1190 30 9	95.0	12	18,000
76.3	31.8	38.1	1190 31 9	98.0	12	18,000
82.5	35.0	41.3	1190 33 9	101.0	12	16,000
88.9	38.1	44.5	1190 34 9	105.0	12	16,000

Max. RPM

⚠ 6mm shank can be supplied with 1/4" shank.
12mm shank can be supplied with 1/2" shank.

Spare Parts:



Ball Bearing
#191 004 0
9.5x4.7x3

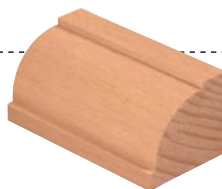

Index

Sawing

CNC

Cutting

Drilling

Routing

Custom Tooling



Routing



Grooving & Sizing

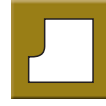

Profiling & Chamfering

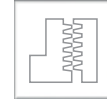

Jointing & Rebating



Carving

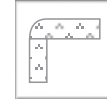

Corian

Matching Corner Round/Cove Bits

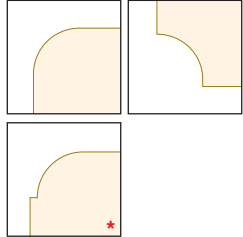
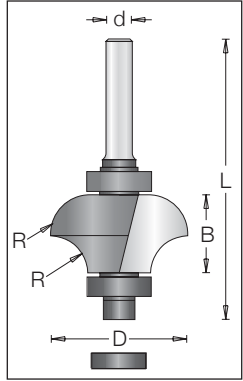

øD	R	B	Code No.	L	ød
28.5	6.3	13.7	1722 02 3	65.7	6
	6.3	13.7	1722 02 5	65.7	8
31.8	8.0	17.0	1722 03 3	69.0	6
	8.0	17.0	1722 03 5	69.0	8
34.8	9.5	20.0	1722 04 3	72.0	6
	9.5	20.0	1722 04 5	72.0	8

⚠ Can be supplied with 1/4" shank.

Spare Parts:



Ball Bearing
#191 024 0
8x16x5

øD	R	B	Code No.	L	ød
28.5	6.3	13.7	1722 12 3	64.7	6
	6.3	13.7	1722 12 5	64.7	8
31.8	8.0	17.0	1722 13 3	68.0	6
	8.0	17.0	1722 13 5	68.0	8
34.8	9.5	20.0	1722 14 3	71.0	6
	9.5	20.0	1722 14 5	71.0	8

Spare Parts:



Ball Bearing
#191 024 0
8x16x5



Ball Bearing *
#191 031 0
8x14x4

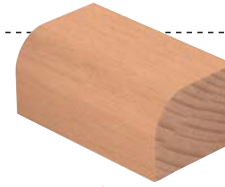

Routing

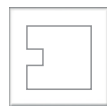

Grooving & Sizing



Profiling & Chamfering

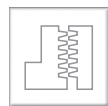

Jointing & Rebating



Carving

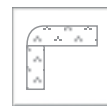

Corian



Core Bit

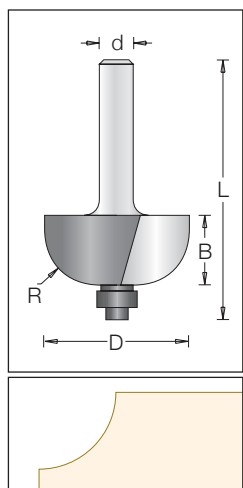

øD	R	B	Code No.	L	ød
12.7	1.6	12.7	1120 02 3	51.0	6
	1.6	12.7	1120 02 5	54.0	8
15.9	3.2	12.7	1120 03 3	51.0	6
	3.2	12.7	1120 03 5	54.0	8
19.1	4.8	14.3	1120 01 3	51.0	6
	4.8	14.3	1120 01 5	54.0	8
22.2	6.3	14.3	1120 04 3	51.0	6
	6.3	14.3	1120 04 5	54.0	8
25.4	7.9	14.3	1120 07 3	51.0	6
	7.9	14.3	1120 07 5	55.0	8
28.6	9.5	14.3	1120 10 3	52.0	6
	9.5	14.3	1120 10 5	55.0	8
34.9	12.7	16.7	1120 13 3	55.0	6
	12.7	16.7	1120 13 5	55.0	8
12.7	1.6	12.7	1120 02 9	60.0	12
15.9	3.2	12.7	1120 03 9	60.0	12
19.1	4.8	14.3	1120 01 9	60.5	12
22.2	6.3	14.3	1120 04 9	60.5	12
25.4	7.9	14.3	1120 07 9	60.5	12
28.6	9.5	14.3	1120 10 9	60.5	12
34.9	12.7	16.7	1120 13 9	64.0	12
41.3	16.0	18.0	1120 15 9	65.0	12
57.1	22.2	31.8	1120 18 9	81.0	12

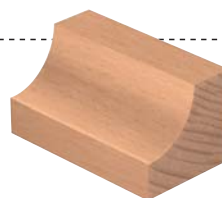

Sawing

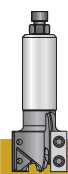

CNC



Cutting

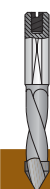

Drilling

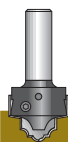

Routing

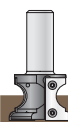

Custom Tooling

⚠ 6mm shank can be supplied with 1/4" shank.
12mm shank can be supplied with 1/2" shank.

Spare Parts:



Ball Bearing
#191 001 0
9.5x3x4

Wavy Edge Bit

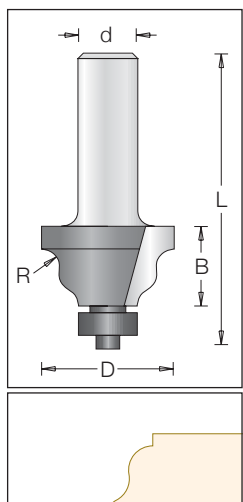

øD	R	B	Code No.	L	ød
31.8	4	17.5	1133 04 3	57	6
	4	17.5	1133 04 5	61	8
	4	17.5	1133 04 9	67	12

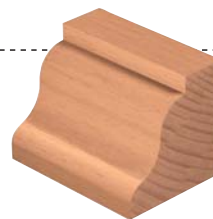

⚠ 6mm shank can be supplied with 1/4" shank.
12mm shank can be supplied with 1/2" shank.

Spare Parts:



Ball Bearing
#191 007 0
12.7x4.7x5



Routing

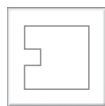

Grooving & Sizing



Profiling & Chamfering

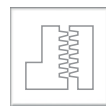

Jointing & Rebating



Carving

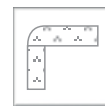

Corian



Index

Roman Ogee Bit

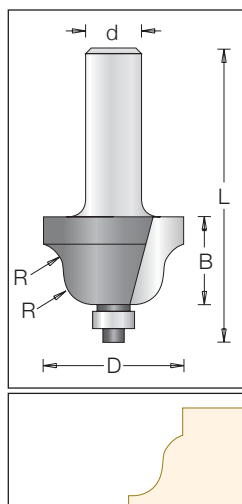

øD	R	B	Code No.	L	ød
25.4	4.0	15.9	1130 01 3	54.0	6
	4.0	15.9	1130 01 5	57.0	8
34.9	6.3	20.0	1130 04 3	58.0	6
	6.3	20.0	1130 04 5	61.5	8
25.4	4.0	15.9	1130 01 9	63.0	12
34.9	6.3	20.0	1130 04 9	67.5	12

⚠ 6mm shank can be supplied with 1/4" shank.
12mm shank can be supplied with 1/2" shank.

Spare Parts:



Ball Bearing
#191 001 0
9.5x3.2x4

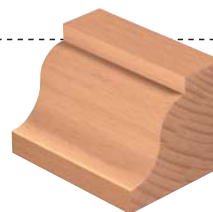

Sawing

Classical Bit

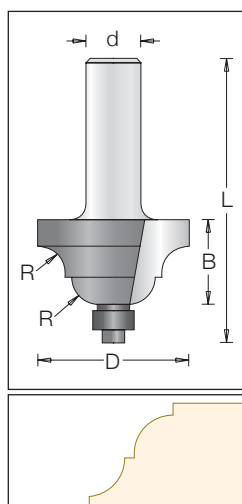

øD	R	B	Code No.	L	ød
25.4	4.0	16	1340 01 3	54.0	6
	4.0	16	1340 01 5	57.5	8
34.9	6.3	20	1340 04 3	56.5	6
	6.3	20	1340 04 5	60.0	8
25.4	4.0	16	1340 01 9	63.5	12
34.9	6.3	20	1340 04 9	66.0	12

⚠ 6mm shank can be supplied with 1/4" shank.
12mm shank can be supplied with 1/2" shank.

Spare Parts:



Ball Bearing
#191 001 0
9.5x3x4

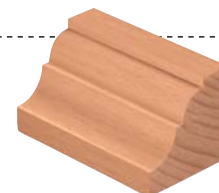

Cutting

Classical Bit

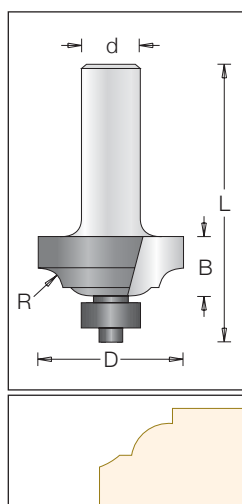

øD	R	B	Code No.	L	ød
31.8	5	13	1200 01 3	53.0	6
	5	13	1200 01 5	56.5	8
38.1	6	16	1200 04 3	55.5	6
	6	16	1200 04 5	59.0	8
31.8	5	13	1200 01 9	62.5	12
38.1	6	16	1200 04 9	65.0	12

⚠ 6mm shank can be supplied with 1/4" shank.
12mm shank can be supplied with 1/2" shank.

Spare Parts:



Ball Bearing
#191 007 0
12.7x4.7x5

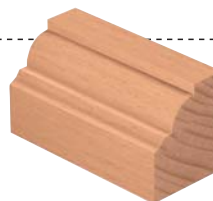

Routing



Custom Tooling

Routing

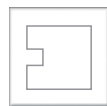

Grooving & Sizing



Profiling & Chamfering

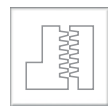

Jointing & Rebating



Carving

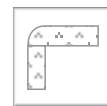

Corian



Classical Bit

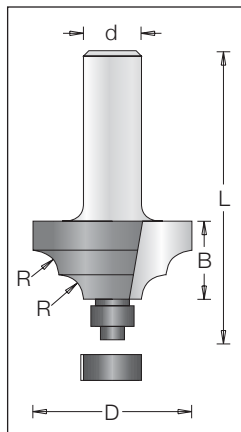

øD	R	B	Code No.	L	ød	
28.6	4.0	12.7	1360 02 3	52.5	6	A
	4.0	12.7	1360 02 5	56.5	8	A
34.9	5.5	17.0	1360 01 3	57.0	6	A
	5.5	17.0	1360 01 5	60.5	8	A
28.6	4.0	12.7	1360 02 9	62.0	12	A
34.9	5.5	17.0	1360 01 9	66.0	12	A
28.6	4.0	12.7	1360 03 3	51.0	6	B
	4.0	12.7	1360 03 5	54.0	8	B
34.9	5.5	17.0	1360 04 3	55.0	6	B
	5.5	17.0	1360 04 5	58.0	8	B
28.6	4.0	12.7	1360 03 9	60.0	12	B
34.9	5.5	17.0	1360 04 9	65.0	12	B
38.1	6.3	19.1	1360 06 9	68.5	12	A
50.8	9.5	22.2	1360 08 9	72.0	12	A

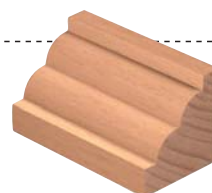

Sawing

⚠ 6mm shank can be supplied with 1/4" shank.
12mm shank can be supplied with 1/2" shank.

Spare Parts:



A. Ball Bearing
#191 007 0
12.7x4.7x5



B. Ball Bearing
#191 004 0
9.5x4.7x3

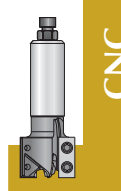

CNC

Classical Moulding Bit

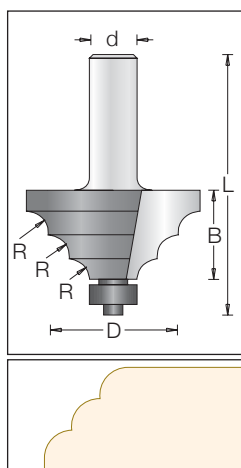

øD	R	B	Code No.	L	ød
47.3	6	23.8	1363 07 9	73	12

⚠ Can be supplied with 1/2" shank.

Spare Parts:



Ball Bearing
#191 007 0
12.7x4.7x5

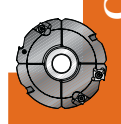
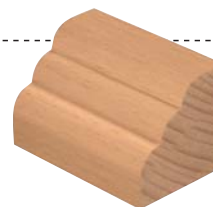

Cutting

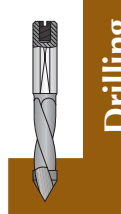

Drilling

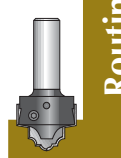

Routing

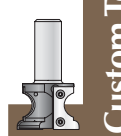

Custom Tooling



Routing

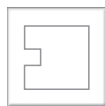

Grooving & Sizing



Profiling & Chamfering

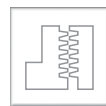

Jointing & Rebating



Carving

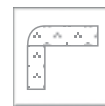

Corian

Ogee Fillet Bit

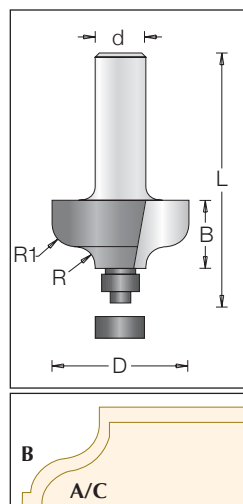

øD	R1	R2	Code No.	B	L	ød	
16.3	2.0	2	1380 05 3	9.5	47.0	6	C
	2.0	2	1380 05 5	9.5	50.5	8	C
28.6	4.5	4	1380 02 3	12.7	52.5	6	A
	4.5	4	1380 02 5	12.7	56.0	8	A
34.9	6.0	5	1380 01 3	17.5	57.0	6	A
	6.0	5	1380 01 5	17.5	60.5	8	A
28.6	4.5	4	1380 02 9	12.7	62.0	12	A
34.9	6.0	5	1380 01 9	17.5	67.0	12	A
28.6	4.5	4	1380 03 3	12.7	51.0	6	B
	4.5	4	1380 03 5	12.7	54.0	8	B
34.9	6.0	5	1380 04 3	17.5	56.0	6	B
	6.0	5	1380 04 5	17.5	59.0	8	B
28.6	4.5	4	1380 03 9	12.7	60.0	12	B
34.9	6.0	5	1380 04 9	17.5	65.0	12	B

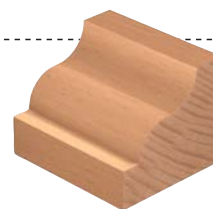

⚠ 6mm shank can be supplied with 1/4" shank.
12mm shank can be supplied with 1/2" shank.

Spare Parts:



A. Ball Bearing
#191 0070
12.7x4.7x5



B. Ball Bearing
#191 004 0
9.5x4.7x3



C. Ball Bearing
#191 002 0
6.3x3x2.8

Classical Mould Bit

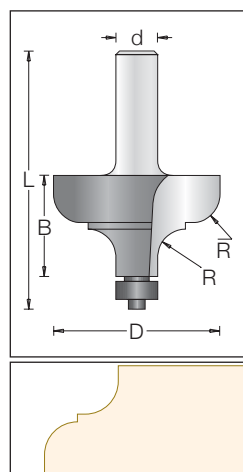

øD	R	Code No.	B	L	ød
51	8.5	1560 41 9	31	80	12

⚠ Can be supplied with 1/2" shank.

Spare Parts:



Ball Bearing
#191 007 0
12.7x4.7x5

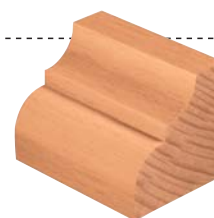

Index

Sawing

CNC

Cutting

Drilling

Routing

Custom Tooling

Routing



Grooving & Sizing



Profiling & Chamfering

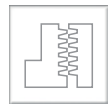

Jointing & Rebating



Carving



Corian



Index

Flat Ogee Bit

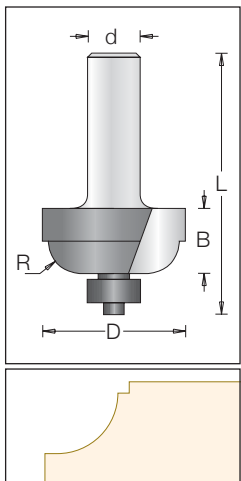

øD	R	Code No.	B	L	ød
28.6	4.8	1400 02 3	12.7	52.0	6
	4.8	1400 02 5	12.7	55.0	8
34.9	7.9	1400 01 3	15.9	55.0	6
	7.9	1400 01 5	15.9	58.0	8
28.6	4.8	1400 02 9	12.7	61.5	12
34.9	7.9	1400 01 9	15.9	65.0	12

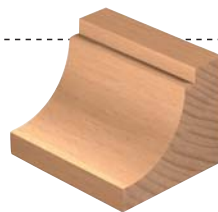

⚠ 6mm shank can be supplied with 1/4" shank.
12mm shank can be supplied with 1/2" shank.

Spare Parts:



Ball Bearing
#191 007 0
12.7x4.7x5



Sawing

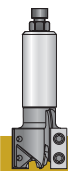

CNC

Ogee Fillet Bit

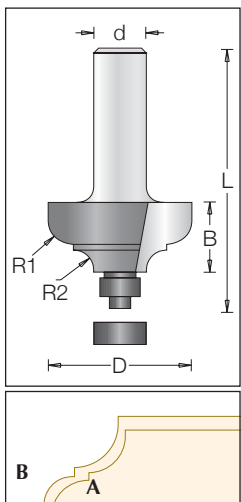

øD	R1	R2	Code No.	B	L	ød	
28.6	4.0	4.0	1350 02 3	12.7	52.5	6	A
	4.0	4.0	1350 02 5	12.7	56.0	8	A
34.9	6.0	5.0	1350 01 3	17.5	56.5	6	A
	6.0	5.0	1350 01 5	17.5	60.0	8	A
28.6	4.5	4.0	1350 02 9	12.7	62.0	12	A
34.9	6.0	4.8	1350 01 9	17.5	66.0	12	A
38.0	4.7	8.0	1350 07 9	16.0	65.0	12	A
51.0	9.5	9.5	1350 06 9	23.0	72.0	12	A
28.6	4.0	4.0	1350 03 3	12.7	51.0	6	B
	4.0	4.0	1350 03 5	12.7	54.0	8	B
34.9	6.0	5.0	1350 04 3	17.5	55.0	6	B
	6.0	5.0	1350 04 5	17.5	58.5	8	B
28.6	4.0	4.0	1350 03 9	12.7	60.0	12	B
34.9	6.0	4.8	1350 04 9	17.5	64.5	12	B
38.0	4.7	8.0	1350 08 9	16.0	65.0	12	B

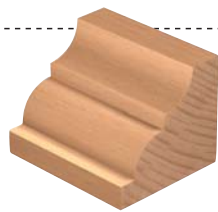

⚠ 6mm shank can be supplied with 1/4" shank.
12mm shank can be supplied with 1/2" shank.

Spare Parts:



A. Ball Bearing
#191 007 0
12.7x4.7x5



B. Ball Bearing
#191 004 0
9.5x4.7x3

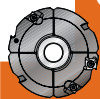

Cutting

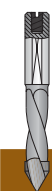

Drilling

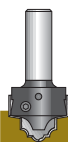

Routing

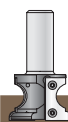

Custom Tooling



Routing

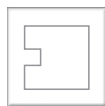

Grooving & Sizing



Profiling & Chamfering

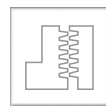

Jointing & Rebating



Carving

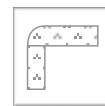

Corian

Ogee Fillet Bit

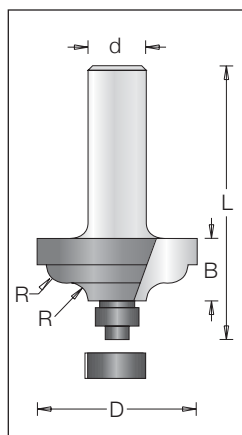

øD	R	B	Code No.	L	ød	
34.9	4.0	13.5	1210 01 3	54.0	6	A
	4.0	13.5	1210 01 5	57.5	8	A
	4.0	13.5	1210 07 3	52.0	6	B
	4.0	13.5	1210 07 5	55.5	8	B
	4.0	13.5	1210 01 9	63.5	12	A
	4.0	13.5	1210 07 9	61.0	12	B
41.3	6.3	19.1	1210 04 9	69.0	12	A
	6.3	19.1	1210 10 9	67.0	12	B
57.2	9.5	25.4	1210 14 9	73.0	12	B
	9.5	25.4	1210 15 9	75.0	12	A

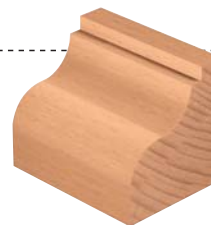

⚠ 6mm shank can be supplied with 1/4" shank.
12mm shank can be supplied with 1/2" shank.

Spare Parts:



A. Ball Bearing
#191 007 0
12.7x4.7x5



B. Ball Bearing
#191 004 0
9.5x4.7x3

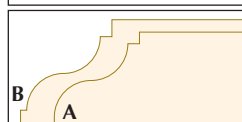

Classic Cove Bit

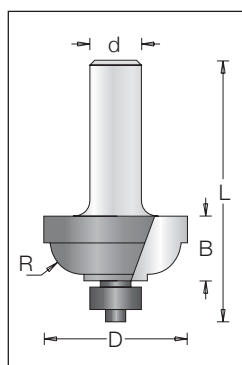

øD	R	Code No.	B	L	ød
28.6	4.8	1390 02 3	12.7	52.0	6
	4.8	1390 02 5	12.7	55.5	8
34.9	7.9	1390 01 3	15.9	55.5	6
	7.9	1390 01 5	15.9	57.0	8
28.6	4.8	1390 02 9	12.7	61.5	12
34.9	7.9	1390 01 9	15.9	65.0	12

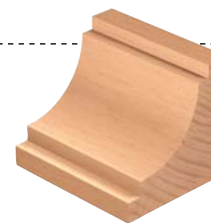

⚠ 6mm shank can be supplied with 1/4" shank.
12mm shank can be supplied with 1/2" shank.

Spare Parts:



Ball Bearing
#191 007 0
12.7x4.7x5

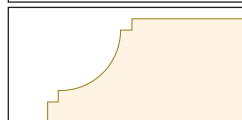

Sunk Bead Bit

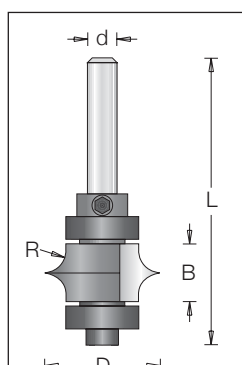

øD	R	Code No.	B	L	ød
25.4	4.8	1570 04 3	12.7	66	6
28.6	6.3	1570 08 3	15.9	69	6
34.5	9.5	1570 12 3	22.2	75	6

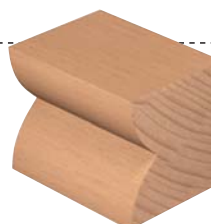

⚠ Can be supplied with 1/4" shank.

Spare Parts:



Ball Bearing
#191 015 0
6.3x16x5



Routing



Grooving & Sizing



Profiling & Chamfering

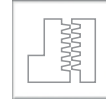

Jointing & Rebating



Carving

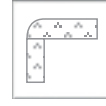

Corian



Corner Bead Cutter

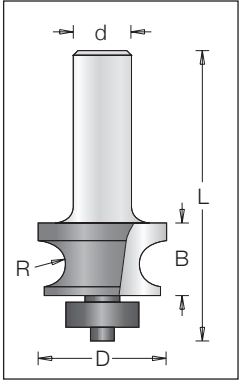

øD	R	Code No.	B	L	ød	
23.0	2.0	1241 05 3	10.3	50.0	6	B
22.2	3.2	1241 08 3	14.3	54.0	6	A
	3.2	1241 08 5	14.3	57.0	8	A
28.2	5.0	1241 11 3	16.5	57.0	6	B
	5.0	1241 11 5	16.5	57.0	8	B
31.8	6.3	1241 13 3	19.1	58.0	6	B
	6.3	1241 13 5	19.1	60.0	8	B
22.2	3.2	1241 08 9	13.5	63.5	12	A
28.2	4.8	1241 11 9	16.5	66.5	12	B
31.8	6.3	1241 13 9	19.1	68.0	12	B
38.1	9.5	1241 17 9	25.4	75.0	12	B

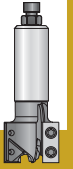
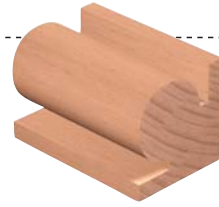

6mm shank can be supplied with 1/4" shank.
12mm shank can be supplied with 1/2" shank.

Spare Parts:



A. Ball Bearing
#191 007 0
12.7x4.7x5



B. Ball Bearing
#191 010 0
16x5x5

Torus Bit

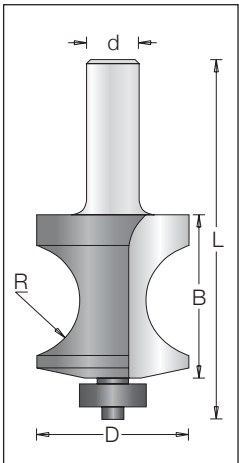

øD	R	Code No.	B	L	ød
37.2	13.5	1244 20 9	40	89	12



Can be supplied with 1/2" shank.

Spare Parts:



Ball Bearing
#191 010 0
5x16x5

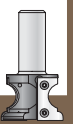
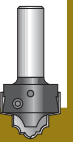
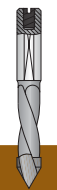
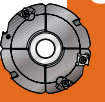



Routing

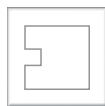

Grooving & Sizing



Profiling & Chamfering

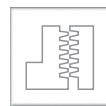

Jointing & Rebating



Carving

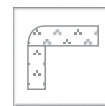

Corian



Bull Nose Bit

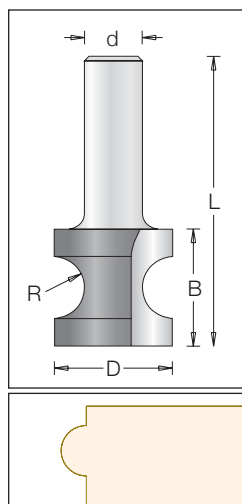

øD	R	Code No.	B	L	ød	n
13.5	2.0	1240 01 3	12.7	41.3	6	
	2.0	1240 01 5	12.7	45.0	8	
15.1	2.8	1240 04 3	12.7	41.3	6	
	2.8	1240 04 5	12.7	45.0	8	
16.7	3.6	1240 07 3	19.1	47.6	6	
	3.6	1240 07 5	19.1	51.0	8	
22.2	5.2	1240 10 3	19.1	47.6	6	
	5.2	1240 10 5	19.1	51.0	8	
26.2	6.8	1240 13 3	25.4	54.0	6	
	6.8	1240 13 5	25.4	57.5	8	
13.5	2.0	1240 01 9	12.7	55.0	12	
15.1	2.8	1240 04 9	12.7	51.0	12	
16.7	3.6	1240 07 9	19.1	57.0	12	
22.2	5.2	1240 10 9	19.1	57.0	12	
26.1	6.8	1240 13 9	25.4	63.5	12	
28.0	7.9	1240 15 9	25.4	63.5	12	
33.3	9.5	1240 17 9	33.7	72.0	12	
42.0	12.7	1240 20 9	39.7	78.0	12	
50.8	15.9	1240 23 9	50.0	88.0	12	
60.3	19.1	1248 26 9-3T	50.8	98.0	12	18,000

Max. RPM

⚠ 6mm shank can be supplied with 1/4" shank.
12mm shank can be supplied with 1/2" shank.

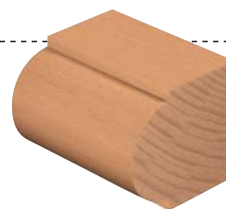

Sawing



CNC



Cutting

Bull Nose Bit

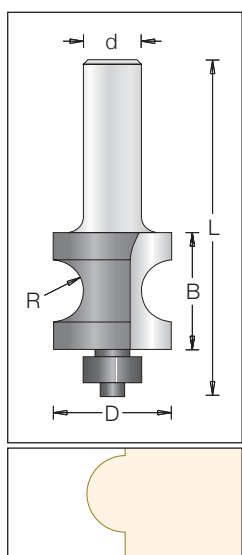

øD	R	Code No.	B	L	ød	⊗
26.2	6.8	1243 13 9	26	75	12	A
35.0	9.5	1243 17 9	34	84	12	B
44.5	12.7	1243 20 9	40	93	12	C
50.8	15.8	1243 23 9	50	103	12	C

⚠ Can be supplied with 1/2" shank.

Spare Parts:



A. Ball Bearing
#191 007 0
12.7x4.7x5



B. Ball Bearing
#191 010 0
16x5x5



C. Ball Bearing
#191 014 0
19x6.3x7

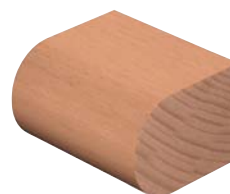

Drilling



Routing

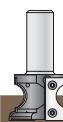

Custom Tooling

Routing

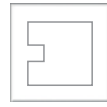

Grooving & Sizing

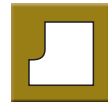

Profiling & Chamfering

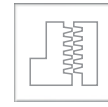

Jointing & Rebating



Carving

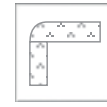

Corian



Plunge Template Bull Nose Bit

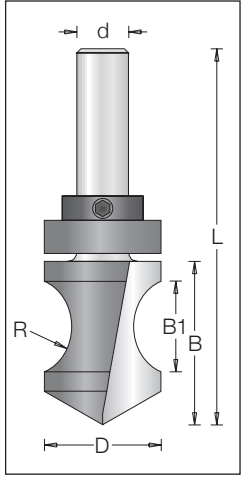

øD	R	Code No.	B	B1	L	ød
28.5	12.7	1240 51 9	40	22.2	92	12
	12.7	1242 51 9 *	40	22.2	92	12

⚠ Can be supplied with 1/2" shank.

Spare Parts:



Ball Bearing *
#191 018 0
28.6x12.7x8

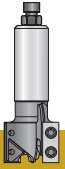
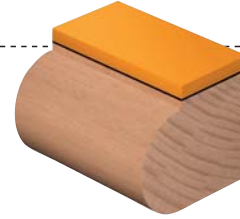

Flat Bull Nose Bit

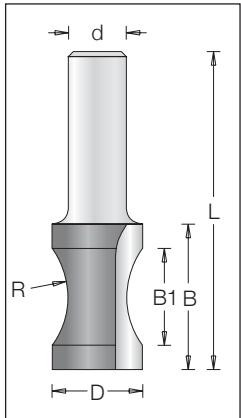

øD	R	Code No.	B	B1	L	ød
20	18	1242 04 3	32	21.3	62	6
	18	1242 04 5	32	21.3	64	8
	18	1242 04 9	32	21.3	70	12

⚠ 6mm shank can be supplied with 1/4" shank.
12mm shank can be supplied with 1/2" shank.

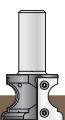
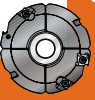
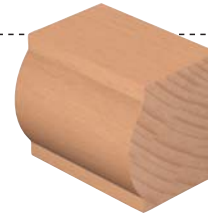



Routing

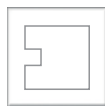

Grooving & Sizing



Profiling & Chamfering

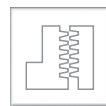

Jointing & Rebating



Carving

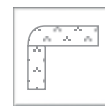

Corian



Adjustable Set - Round Over

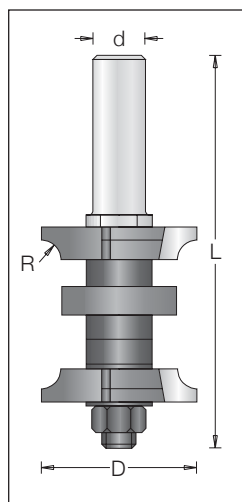

	R	Code No.	øD	B Min.	B Max	L	ød
Complete	4.8	158 000 9	38.1	9.5	38	96	12
Top Cutter	4.8	158 094 0					
Bottom Cutter	4.8	158 095 0					

	R	Code No.	øD	B Min.	B Max	L	ød
Complete	6.35	158 100 9	40.7	12.7	36	96	12
Top Cutter	6.35	158 064 0					
Bottom Cutter	6.35	158 063 0					

	R	Code No.	øD	B Min.	B Max	L	ød
Complete	9.6	158 200 9	47.2	19	36	96	12
Top Cutter	9.6	158 084 0					
Bottom Cutter	9.6	158 083 0					

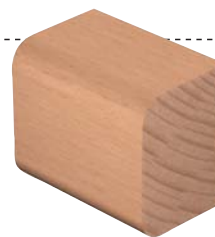

Sawing



CNC

⚠ Can be supplied with 1/2" shank.

Spare Parts:



Arbor & Nut
#190 009 9
L=96



Ball Bearing
#191 016 0
8x28x9



Washer
#192 011 0
1x16



Spacer
#192 016 0
6x16



Spacer
#192 015 0
3x16



Spacer
#192 011 0
1x16



Spacer
#192 013 0
0.5x16



Cutting

Adjustable Set - Dual Radius

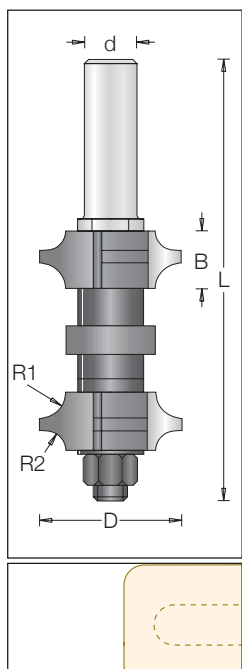

	R	Code No.	øD	B Min.	B Max	L	ød
Complete	4.8/6.3	158 300 9	34.8	9.5/12.7	35/38	108	12
Top Cutter	4.8/6.3	158 302 0					
Bottom Cutter	4.8/6.3	158 301 0					

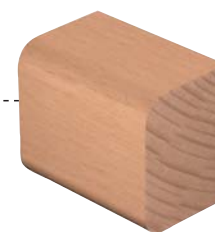

Drilling

⚠ Can be supplied with 1/2" shank.

Spare Parts:



Arbor & Nut
#190 011 9
L=108



Ball Bearing
#191 013 0
8x22x7



Washer
#192 011 0
1x16



Spacer
#192 016 0
6x16



Spacer
#192 015 0
3x16



Spacer
#192 011 0
1x16



Spacer
#192 013 0
0.5x16



Spacer
#192 100 0
0.1x16



Routing



Custom Tooling

Routing

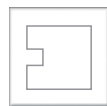

Grooving & Sizing



Profiling & Chamfering

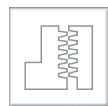

Jointing & Rebating



Carving



Corian



Adjustable Set - Chamfer

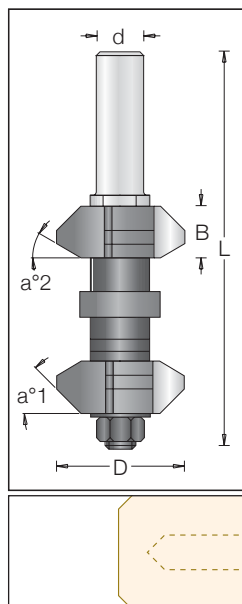

	a°	Code No.	øD	B Max	L	ød
Complete	45°/30°	158 400 9	34.8	42/35	108	12
Top Cutter	45°/30°	158 401 0	34.8			
Bottom Cutter	45°/30°	158 402 0	34.8			

⚠ Can be supplied with 1/2" shank.

Spare Parts:



Arbor & Nut
#190 011 9
L=108



Ball Bearing
#191 013 0
8x22x7



Washer
#192 011 0
1x16



Spacer
#192 016 0
6x16



Spacer
#192 015 0
3x16



Spacer
#192 011 0
1x16



Spacer
#192 013 0
0.5x16



Spacer
#192 100 0
0.1x16

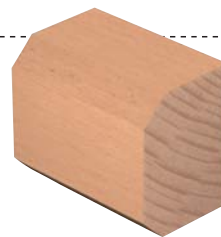

Sawing

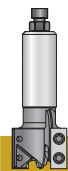

CNC

Double Bead Bit

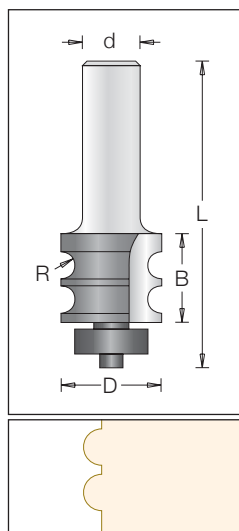

øD	R	Code No.	B	L	ød
22.2	3	1243 08 9	19.1	69	12

⚠ Can be supplied with 1/2" shank.

Spare Parts:



Ball Bearing
#191 010 0
5x16x5

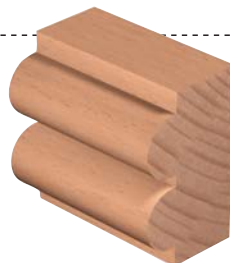

Cutting

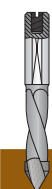

Drilling

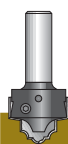

Routing

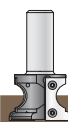

Custom Tooling



Routing

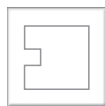

Grooving & Sizing



Profiling & Chamfering

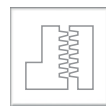

Jointing & Rebating



Carving

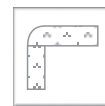

Corian



Index

Triple Bead Bit

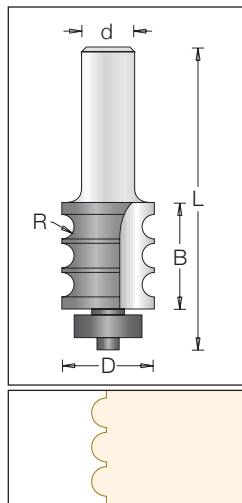

øD	R	Code No.	B	L	ød
22.2	3	1243 32 3	25.4	65	6
	3	1243 32 9	25.4	74	12

⚠ 6mm shank can be supplied with 1/4" shank.
12mm shank can be supplied with 1/2" shank.

Spare Parts:



Ball Bearing
#191 010 0
5x16x5

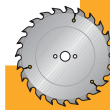
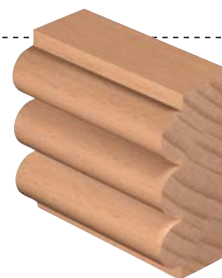

Sawing

Flat Sunk Bead Bit

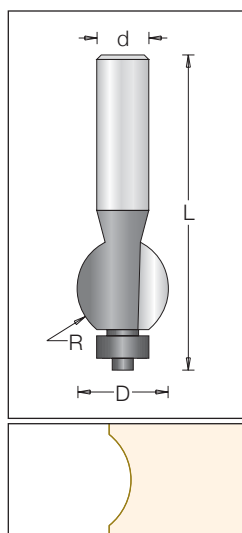

øD	R	Code No.	B	L	ød
19.1	8.0	1623 02 9	12.7	70	12
22.2	12.0	1623 04 9	19.1	78	12
	19.5	1623 05 9	25.4	85	12
25.4	32.0	1623 06 9	38.1	98	12

⚠ Can be supplied with 1/2" shank.

Spare Parts:



Ball Bearing
#191 007 0
12.7x4.7x5

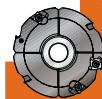
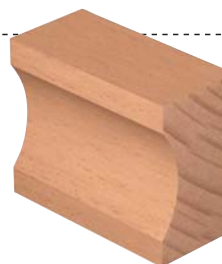

Cutting

Reed Edge Mould Bit

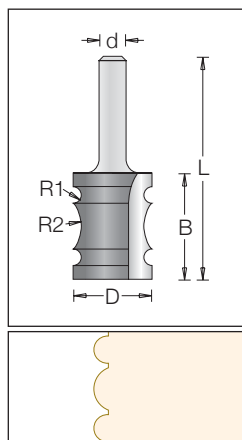

øD	R1	R2	Code No.	B	L	ød
19.1	2	6	1243 09 3	25.4	55	6

⚠ Can be supplied with 1/4" shank.

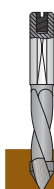
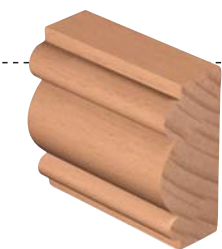

Drilling



Routing

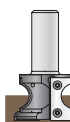

Custom Tooling

Routing



Grooving & Sizing

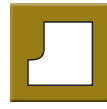

Profiling & Chamfering

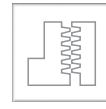

Jointing & Rebating



Carving

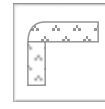

Corian



Sunk Bead Bit

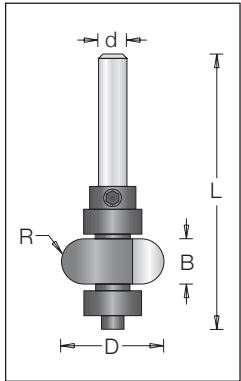

øD	R	Code No.	B	L	ød
19.1	3.2	1622 02 3	6.4	57	6
22.7	5.0	1622 05 3	10.0	61	6

⚠ Can be supplied with 1/4" shank.

Spare Parts:



Ball Bearing
#191 007 0
12.7x4.7x5



Ball Bearing
#191 003 0
12.7x6.3x4.7

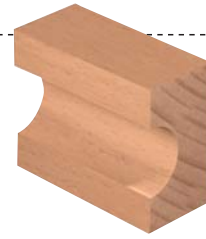

Sunk Bead Bit

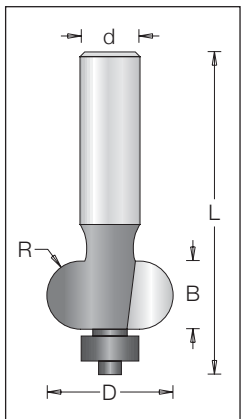

øD	R	Code No.	B	L	ød
20.7	4.0	1620 04 3	8	47	6
22.7	5.0	1620 05 3	10	49	6
24.7	6.0	1620 06 3	12	51	6
27.7	7.5	1620 07 9	15	70	12
32.7	10.0	1620 10 9	20	75	12

⚠ 6mm shank can be supplied with 1/4" shank.
12mm shank can be supplied with 1/2" shank.

Spare Parts:



Ball Bearing
#191 007 0
12.7x4.7x5

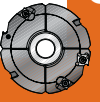
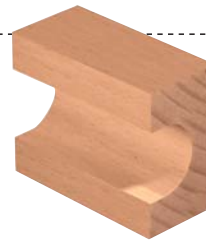

Window Sill Edge Bit

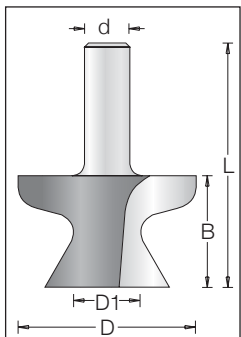

øD	øD1	Code No.	B	L	ød
50.8	19.1	1480 40 9	32	70	12

⚠ Can be supplied with 1/2" shank.

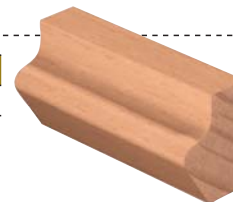



Routing



Grooving & Sizing



Profiling & Chamfering

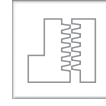

Jointing & Rebating



Carving

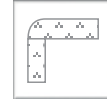

Corian

Finger Grip Bit

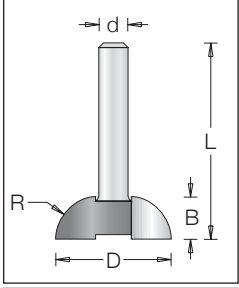

øD	R	Code No.	B	L	ød
19.1	6.5	1320 01 3	6.3	44.5	6
	6.5	1320 01 5	6.3	44.5	8
25.4	9.5	1320 04 3	9.5	44.5	6
	9.5	1320 04 5	9.5	44.5	8

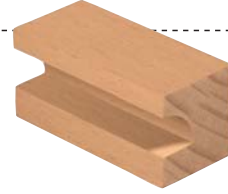

⚠ Can be supplied with 1/4" shank.

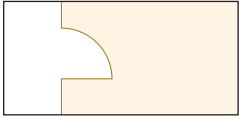

Finger Grip Bit

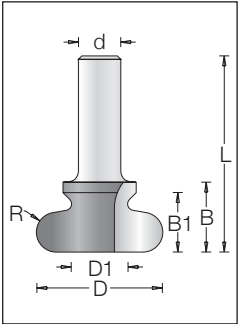

øD	D1	Code No.	B	B1	R	L	ød
19.1	10	1480 19 5	19.1	14.3	4.8	54.5	8
	10	1480 19 9	19.1	14.3	4.8	57.5	12
38.1	17	1480 31 5	21.0	18.0	6.0	53.0	8
	17	1480 31 9	21.0	18.0	6.0	59.0	12
45.0	17	1480 37 9	21.0	17.2	4.8	59.0	12

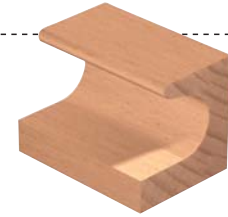

⚠ Can be supplied with 1/2" shank.

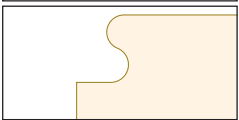

Finger Grip Bit

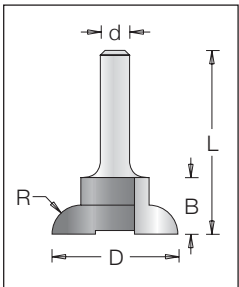

øD	R	Code No.	B	L	ød
28	6.35	1320 10 3	12.7	41	6

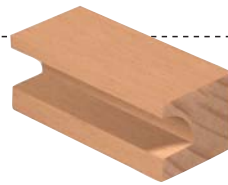

⚠ Can be supplied with 1/4" shank.



Routing

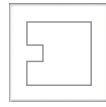

Grooving & Sizing

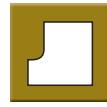

Profiling & Chamfering

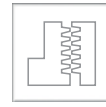

Jointing & Rebating

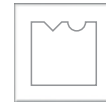

Carving

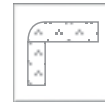

Corian



Set of Stile & Rail Bit

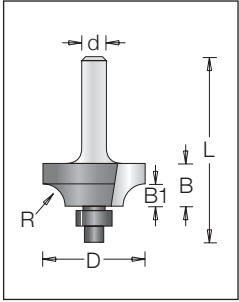

øD	Code No.	B	B1	R	L	ød	
Set No.	1490 75 3						
27.5	1490 73 3	11.5	6	6	50	6	A
30.7	1492 74 3	9.0	6	6	47	6	B

⚠ Can be supplied with 1/4" shank.

Spare Parts:



A. Ball Bearing
#1910010
9.5x3x4



B. Ball Bearing
#1910030
12.7x6.3x4.7

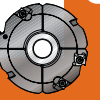
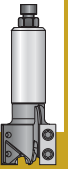
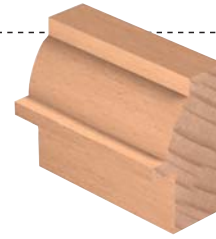
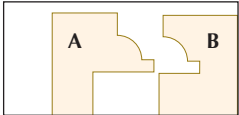
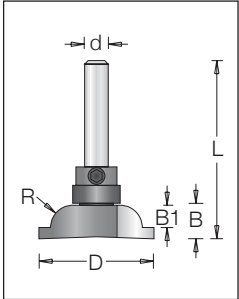

Flat Bull - Nose Bead Bit

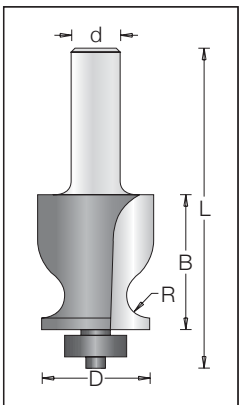

øD	R	Code No.	B	L	ød
30	6	1560 44 9	35	84.5	12

⚠ Can be supplied with 1/2" shank.

Spare Parts:



Ball Bearing
#191 010 0
5x16x5

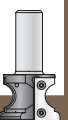
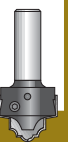
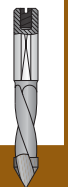
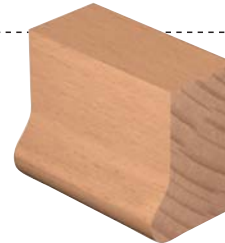
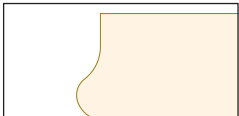



Routing

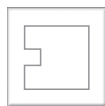

Grooving & Sizing



Profiling & Chamfering

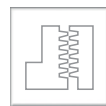

Jointing & Rebating



Carving

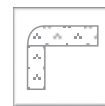

Corian



Index

Bull Nose Mould Bit

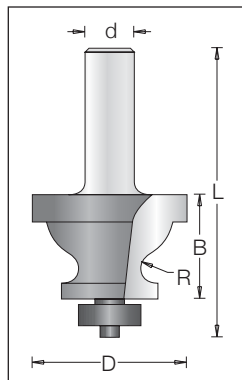

øD	R	Code No.	B	L	ød
40	4	1560 53 9	27	76	12

⚠ Can be supplied with 1/2" shank.

Spare Parts:



Ball Bearing
#191 010 0
5x16x5

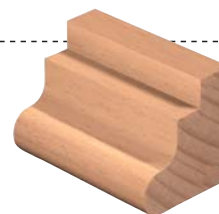

Sawing

Profile Edge Mould Bit

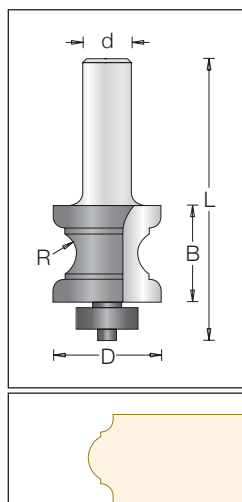

øD	R	Code No.	B	L	ød
28	6	1243 01 9	25	74	12
32	8	1243 04 9	30	79	12
35	13	1243 05 9	40	89	12

⚠ Can be supplied with 1/2" shank.

Spare Parts:



Ball Bearing
#191 010 0
5x16x5

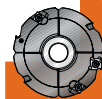
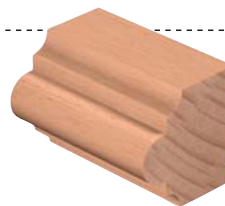

Cutting

Decorative Bead Bit

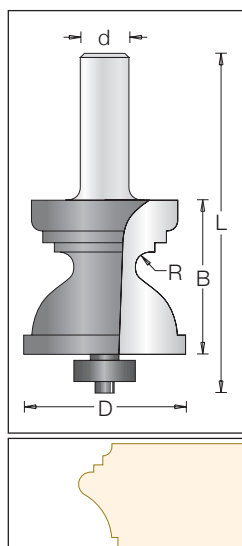

øD	R	Code No.	B	L	ød
42	4	1566 02 9	40	89	12

⚠ Can be supplied with 1/2" shank.

Spare Parts:



Ball Bearing
#191 010 0
5x16x5

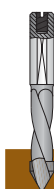
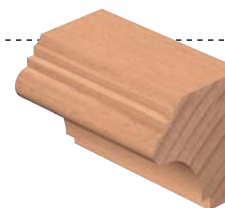

Drilling



Routing

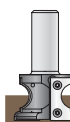

Custom Tooling

Routing

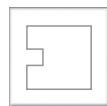

Grooving & Sizing



Profiling & Chamfering

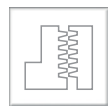

Jointing & Rebating



Carving



Corian



Classic Corner Bead Bit

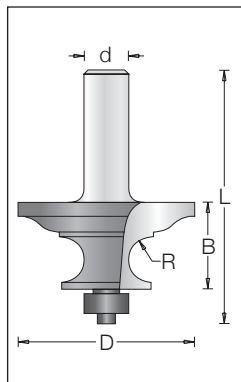

øD	R	Code No.	B	L	ød
50.8	6.5	1560 40 9	25.4	75	12

⚠ Can be supplied with 1/2" shank.

Spare Parts:



Ball Bearing
#191 007 0
12.7x4.7x5

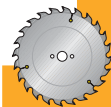
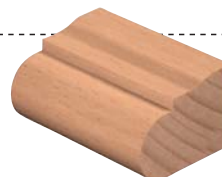

Sawing



Profile Edge Mould Bit

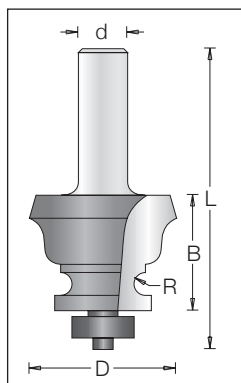

øD	R	Code No.	B	L	ød
38.1	3	1560 56 9	30	79	12

⚠ Can be supplied with 1/2" shank.

Spare Parts:



Ball Bearing
#191 010 0
5x16x5

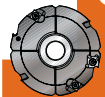
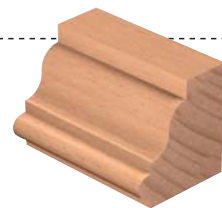

Cutting



Frame Edge Profiling Bit

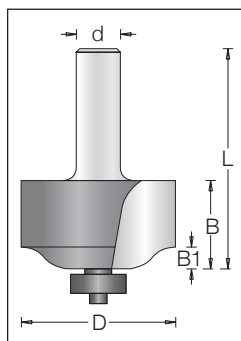

øD	Code No.	B	B1	L	ød
45	1563 06 9	25.4	6.35	75	12

⚠ Can be supplied with 1/2" shank.

Spare Parts:



Ball Bearing
#191 006 0
16x4.7x5

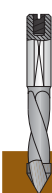
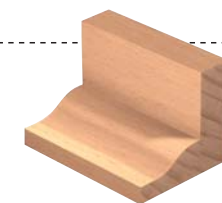

Drilling

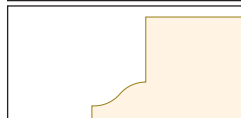

Routing



Custom Tooling



Routing

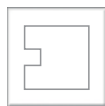

Grooving & Sizing



Profiling & Chamfering

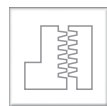

Jointing & Rebating

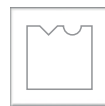

Carving

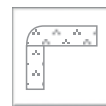

Corian



Index

Face Moulding Bit

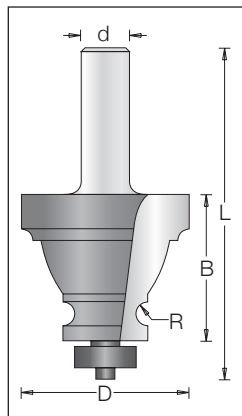

øD	R	Code No.	B	L	ød
43.5	3	1560 50 9	38.1	87	12

⚠ Can be supplied with 1/2" shank.

Spare Parts:



Ball Bearing
#191 010 0
5x16x5

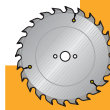
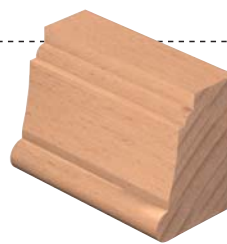

Sawing



CNC

Frame Edge Profiling Bit

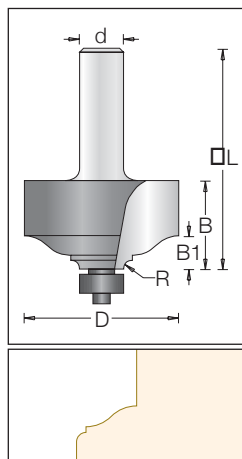

øD	R	Code No.	B	B1	L	ød
44.5	75	1563 07 9	25.4	9.4	2.5	12

⚠ Can be supplied with 1/2" shank.

Spare Parts:



Ball Bearing
#191 007 0
12.7x4.7x5

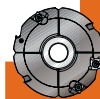
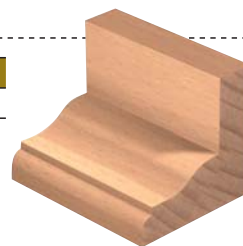

Cutting



Drilling

Plant Mould Bit

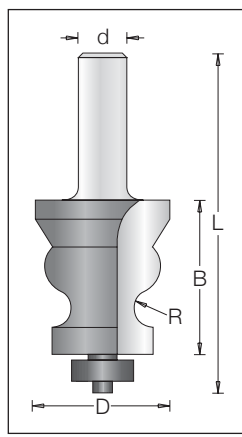

øD	R	Code No.	B	L	ød
35	5	1560 47 9	38.1	87	12

⚠ Can be supplied with 1/2" shank.

Spare Parts:



Ball Bearing
#191 010 0
5x16x5

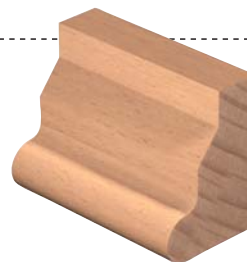

Routing

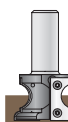

Custom Tooling

Routing



Grooving & Sizing



Profiling & Chamfering

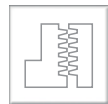

Jointing & Rebating



Carving

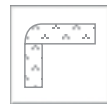

Corian



Face Moulding Bit

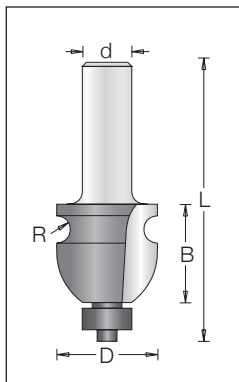

øD	R	Code No.	B	L	ød
26	3.5	1563 03 9	25.4	74	12

⚠ Can be supplied with 1/2" shank.

Spare Parts:



Ball Bearing
#191 007 0
12.7x4.7x5

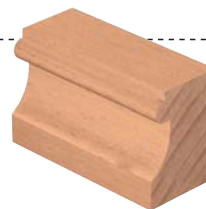

Sawing

Face Moulding Bit

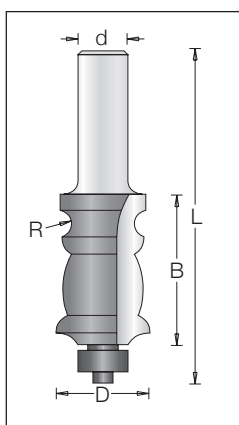

øD	R	Code No.	B	L	ød
24	3.5	1560 09 9	39	89	12

⚠ Can be supplied with 1/2" shank.

Spare Parts:



Ball Bearing
#191 007 0
12.7x4.7x5

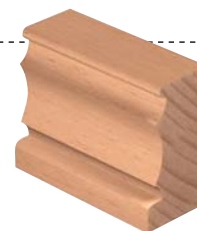

Cutting

Face Moulding Bit

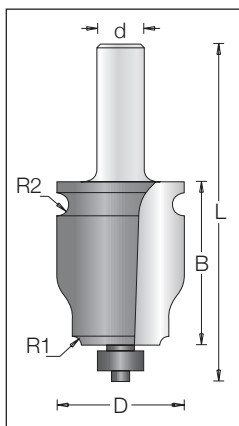

øD	R1	R2	Code No.	B	L	ød
35	2.5	3.2	1563 04 9	45	94	12

⚠ Can be supplied with 1/2" shank.

Spare Parts:



Ball Bearing
#191 007 0
12.7x4.7x5

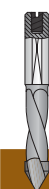
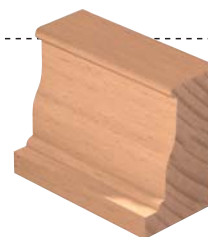

Drilling

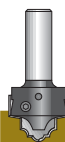

Routing



Custom Tooling

Routing



Grooving & Sizing



Profiling & Chamfering

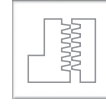

Jointing & Rebating



Carving

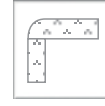

Corian

Index

Face Moulding Bit

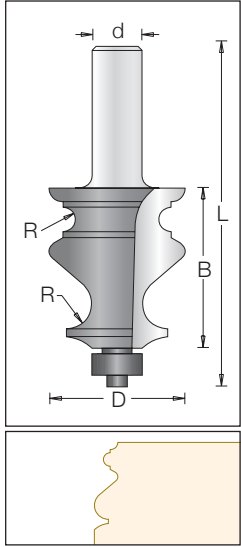

øD	R1	R2	Code No.	B	L	ød
34.7	6.5	3.2	1563 01 9	41.5	90.5	12

⚠ Can be supplied with 1/2" shank.

Spare Parts:



Ball Bearing
#191 007 0
12.7x4.7x5

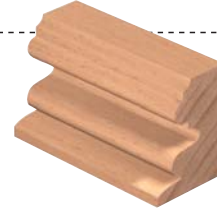

Sawing



CNC

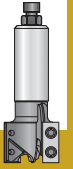

Face Moulding Bit

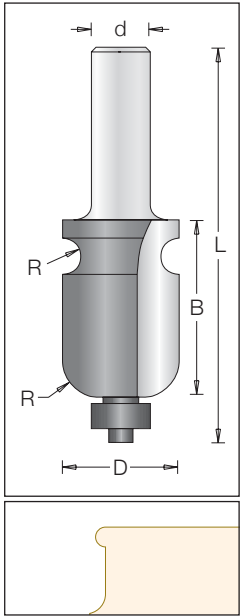

øD	R1	R2	Code No.	B	L	ød
25.4	4	8	1560 06 9	38.1	87	12

⚠ Can be supplied with 1/2" shank.

Spare Parts:



Ball Bearing
#191 007 0
3/16x1/2x5

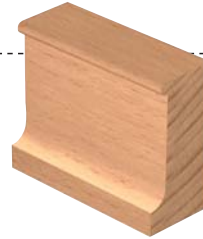

Cutting

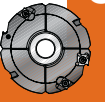

Drilling

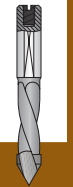

Routing

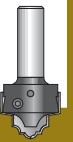

Custom Tooling

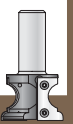

Routing



Grooving & Sizing



Profiling & Chamfering

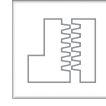

Jointing & Rebating



Carving

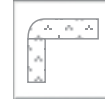

Corian



Index



Face Moulding Bit

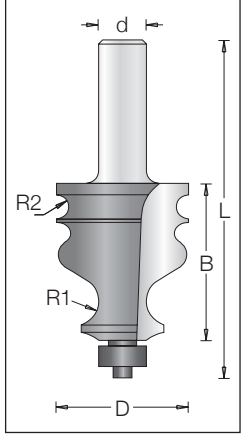

øD	R1	R2	Code No.	B	L	ød
35	6.5	3.2	1563 02 9	41.5	91	12

⚠ Can be supplied with 1/2" shank.

Spare Parts:



Ball Bearing
#191 007 0
12.7x4.7x5

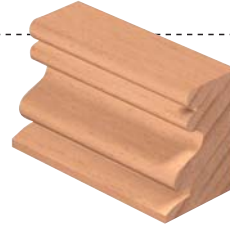

Sawing



CNC

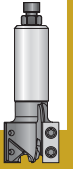

Face Moulding Bit

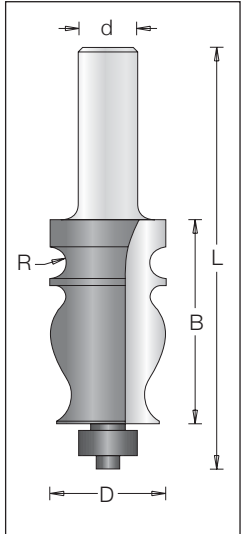

øD	R	Code No.	B	L	ød
25.4	3.5	1560 21 9	45	94	12

⚠ Can be supplied with 1/2" shank.

Spare Parts:



Ball Bearing
#191 007 0
12.7x4.7x5

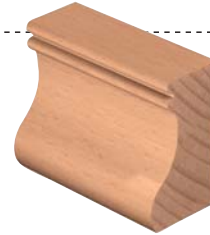

Cutting



Drilling

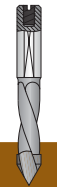

Routing

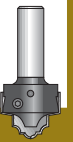

Custom Tooling

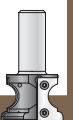



Routing

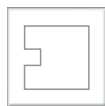

Grooving & Sizing



Profiling & Chamfering

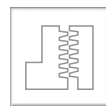

Jointing & Rebating



Carving

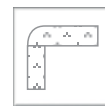

Corian

Face Moulding Bit

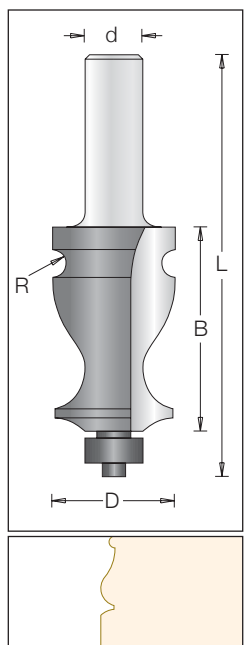

$\varnothing D$	R	Code No.	B	L	$\varnothing d$
27	3	1560 13 9	45	94	12

Can be supplied with 1/2" shank.

Spare Parts:



Ball Bearing
#191 007 0
12.7x4.7x5

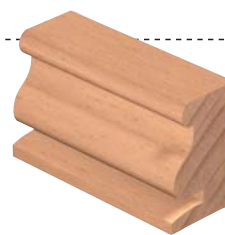

Face Moulding Bit

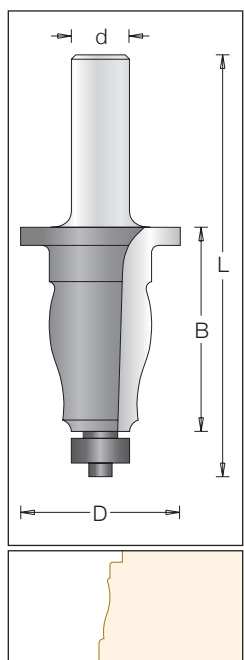

$\varnothing D$	B	Code No.	L	$\varnothing d$
35	44.5	1563 08 9	94	12

Can be supplied with 1/2" shank.

Spare Parts:



Ball Bearing
#191 007 0
12.7x4.7x5

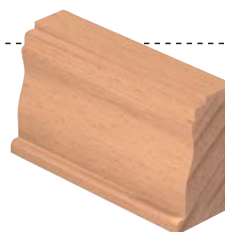

Index

Sawing

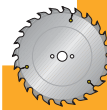

CNC



Cutting



Drilling



Routing



Custom Tooling

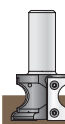

Routing

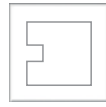

Grooving & Sizing

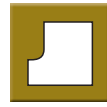

Profiling & Chamfering

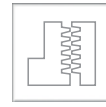

Jointing & Rebating

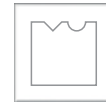

Carving

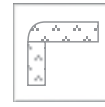

Corian



Face Moulding Bit

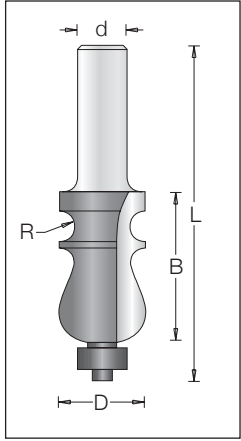

øD	R	Code No.	B	L	ød
22	4	1560 07 9	38	87	12

⚠ Can be supplied with 1/2" shank.

Spare Parts:



Ball Bearing
#191 007 0
12.7x4.7x5

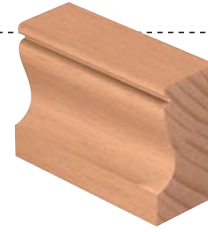

Decorative Moulding Bit

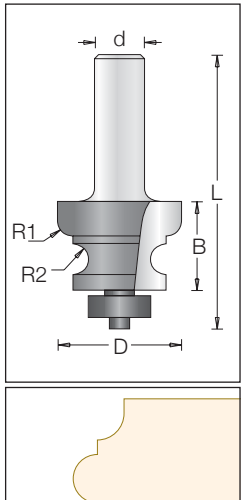

øD	R1	R2	Code No.	B	L	ød	
20.7	2.0	2	1566 04 9	15.0	64.3	12	A
32.0	4.0	4	1566 05 9	23.0	72.0	12	B
40.0	5.5	5	1566 03 9	30.0	79.0	12	B

⚠ Can be supplied with 1/2" shank.

Spare Parts:



A. Ball Bearing
#191 007 0
12.7x4.7x5



B. Ball Bearing
#191 100 0
16x5x5

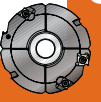
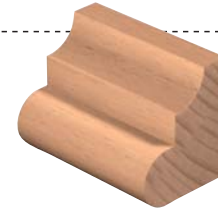

French Provincial Bit

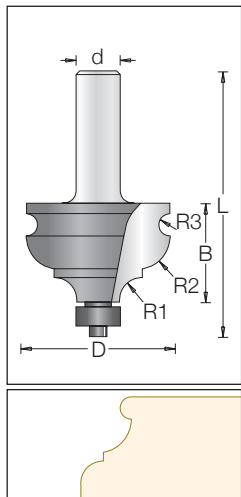

øD	R1	R2	R3	Code No.	B	L	ød
41.3	6.35	9.5	3.2	1560 34 9	28.5	78	12

⚠ Can be supplied with 1/2" shank.

Spare Parts:



Ball Bearing
#191 007 0
12.7x4.7x5

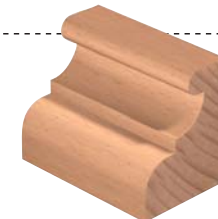



Routing



Grooving & Sizing



Profiling & Chamfering

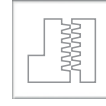

Jointing & Rebating



Carving

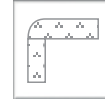

Corian

Decorative and Jointer Bit

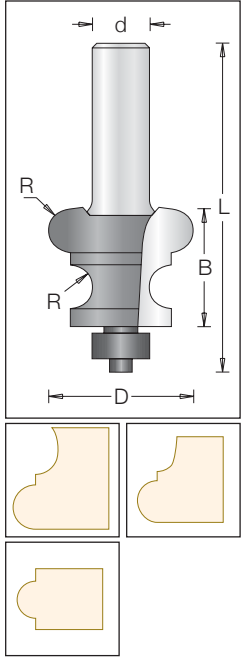

øD	R	Code No.	B	L	ød	
25.4	3.2	1560 37 3	16.5	57	6	A
31.8	4.8	1560 38 3	25.4	64	6	A
	4.8	1560 38 9	25.4	74	12	A
50.8	6.5	1560 39 9	32.0	80	12	B

⚠ 6mm shank can be supplied with 1/4" shank.
12mm shank can be supplied with 1/2" shank.

Spare Parts:



A. Ball Bearing
#191 007 0
12.7x4.7x5



B. Ball Bearing
#191 010 0
16x5x5

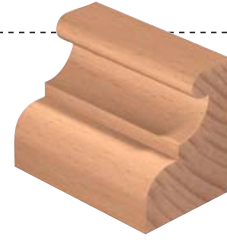

Classical Elegant Mould Bit

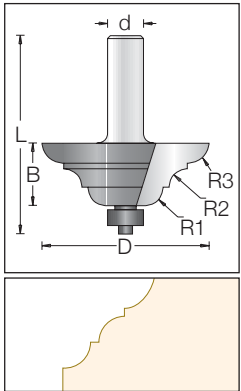

øD	R1	R2	R3	Code No.	B	L	ød
59	6.5	6.5	7.5	1650 10 9	22	71	12

⚠ Can be supplied with 1/2" shank.

Spare Parts:



Ball Bearing
#191 007 0
12.7x4.7x5

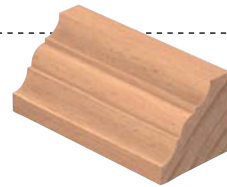

Routing



Grooving & Sizing



Profiling & Chamfering

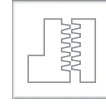

Jointing & Rebating



Carving

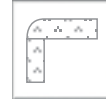

Corian



Index

Multi - Profile Bit

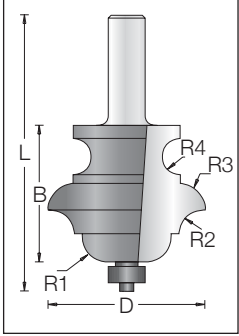

øD	R1	R2	R3	R4	Code No.	B	L	ød	n
54	9	9	8.5	6.3	1660 06 9	47	97	12	18,000

⚠ Can be supplied with 1/2" shank.

Max. RPM

Spare Parts:



Ball Bearing
#191 007 0
12.7x4.7x5

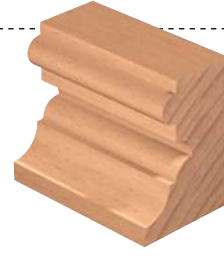

Sawing



Cornice Profiling Bit

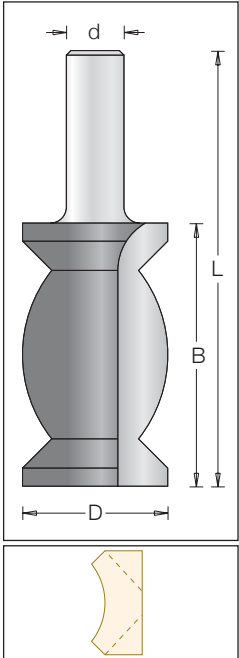

øD	B	Code No.	L	ød
32	58	1560 05 9	96	12

⚠ Can be supplied with 1/2" shank.

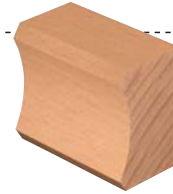

CNC

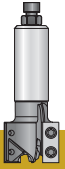

Cutting

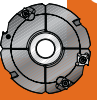

Drilling

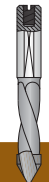

Routing



Custom Tooling

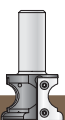



Routing



Grooving & Sizing



Profiling & Chamfering

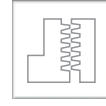

Jointing & Rebating



Carving

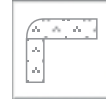

Corian

Index

Cornice Profiling Bit

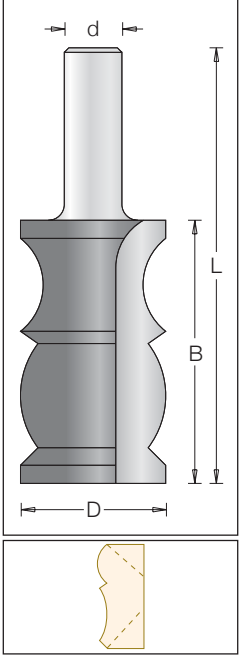

øD	B	Code No.	L	ød
32	58	1560 04 9	96	12

⚠ Can be supplied with 1/2" shank.

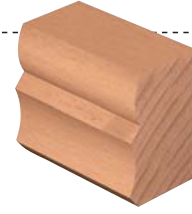

Sawing



CNC

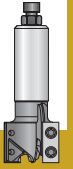

Cornice Profiling Bit

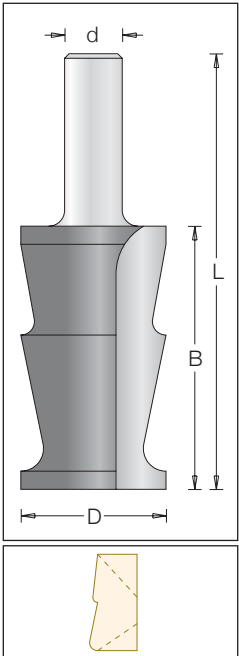

øD	B	Code No.	L	ød
32	58	1560 11 9	96	12

⚠ Can be supplied with 1/2" shank.

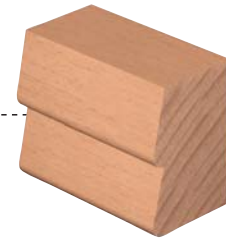

Cutting

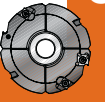

Drilling

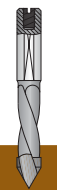

Routing

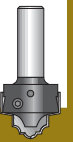

Custom Tooling

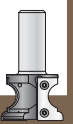

Routing



Grooving & Sizing



Profiling & Chamfering

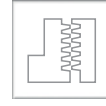

Jointing & Rebating



Carving



Corian



Index

Cornice Profiling Bit

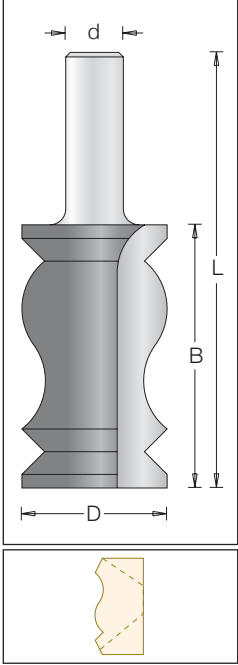

$\varnothing D$	B	Code No.	L	$\varnothing d$
32	58	1560 08 9	96	12

⚠ Can be supplied with 1/2" shank.



Sawing



CNC

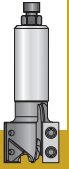

Cornice Profiling Bit

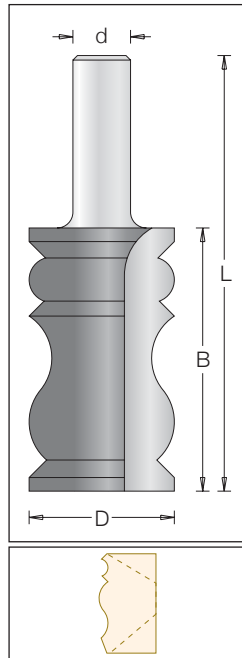

$\varnothing D$	B	Code No.	L	$\varnothing d$
31.4	58	1560 03 9	96	12

⚠ Can be supplied with 1/2" shank.

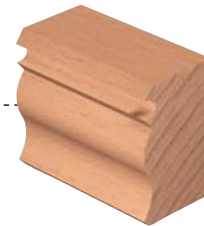

Cutting

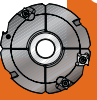

Drilling

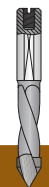

Routing

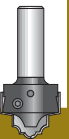

Custom Tooling

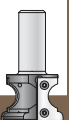



Routing

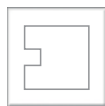

Grooving & Sizing



Profiling & Chamfering

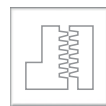

Jointing & Rebating



Carving

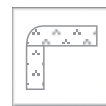

Corian



Index

Handrail Bit

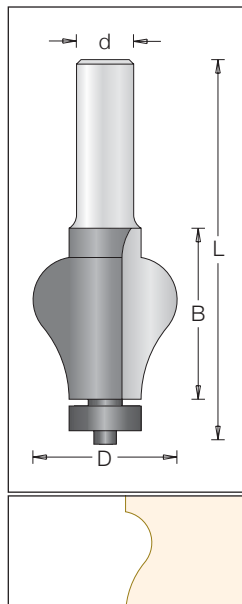

øD	B	Code No.	L	ød
32	38	1630 11 9	87	12

⚠ Can be supplied with 1/2" shank.

Spare Parts:



Ball Bearing
#191 010 0
5x16x5

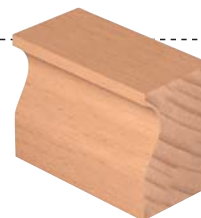

Sawing

Handrail Bit

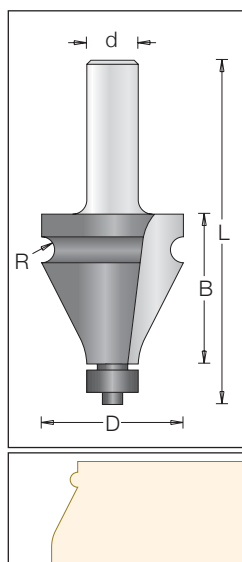

øD	R	B	Code No.	L	ød
35	3.2	37	1630 04 9	86	12

⚠ Can be supplied with 1/2" shank.

Spare Parts:



Ball Bearing
#191 007 0
12.7x4.7x5

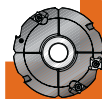
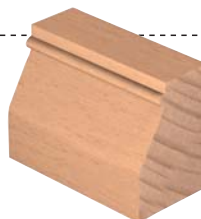

Cutting

Thumbnail Bit

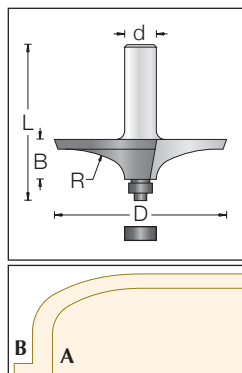

øD	R	B	Code No.	L	ød	n	
69.2	43	16	1092 28 9	76	12	18,000	A
	43	16	1192 28 9	74	12	18,000	B

⚠ Can be supplied with 1/2" shank.

Spare Parts:



A. Ball Bearing
#191 007 0
12.7x4.7x5



B. Ball Bearing
#191 004 0
9.5x4.7x3

Max. RPM

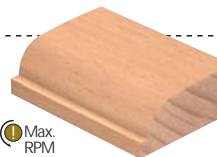

Routing

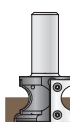

Custom Tooling

Routing



Grooving & Sizing

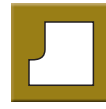

Profiling & Chamfering

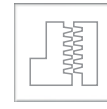

Jointing & Rebating



Carving

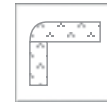

Corian



Handrail Bit

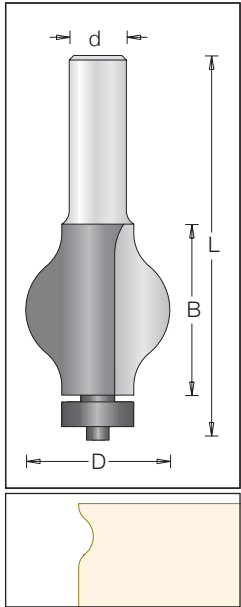

øD	B	Code No.	L	ød
32	38	1630 12 9	87	12

⚠ Can be supplied with 1/2" shank.

Spare Parts:



Ball Bearing
#191 010 0
5x16x5

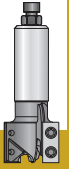
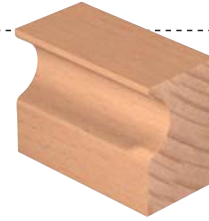

Classical Bit

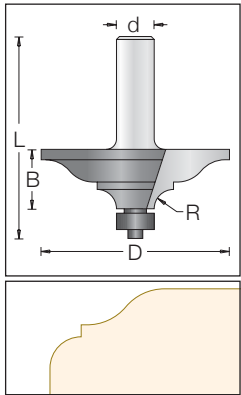

øD	R	B	Code No.	L	ød
63.5	6.5	20	1650 07 9	79	12

⚠ Can be supplied with 1/2" shank.

Spare Parts:



Ball Bearing
#191 007 0
12.7x4.7x5

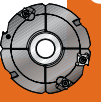
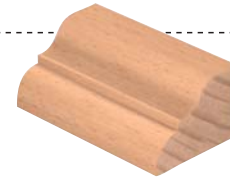

Traditional Bit

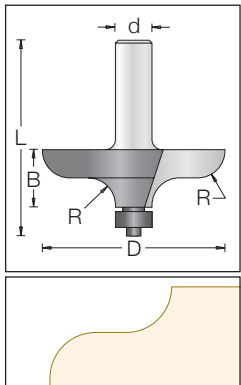

øD	R	B	Code No.	L	ød
63.5	9.5	20	1650 04 9	79	12

⚠ Can be supplied with 1/2" shank.

Spare Parts:



Ball Bearing
#191 007 0
12.7x4.7x5

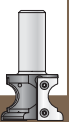
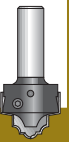
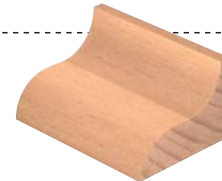



Routing

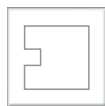

Grooving & Sizing



Profiling & Chamfering

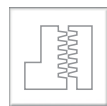

Jointing & Rebating

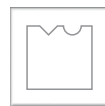

Carving

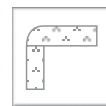

Corian



Index

Classic Elegant Bit

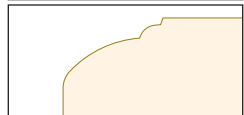
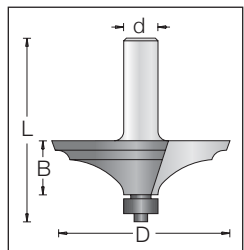

øD	B	Code No.	L	ød	n
66	20	1650 13 9	79	12	18,000

Max. RPM

⚠ Can be supplied with 1/2" shank.

Spare Parts:



Ball Bearing
#191 007 0
12.7x4.7x5

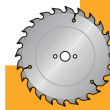
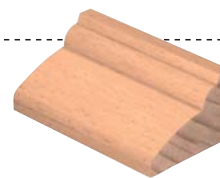

Sawing

Raised Panel Bit

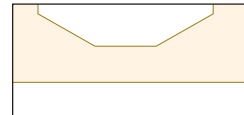
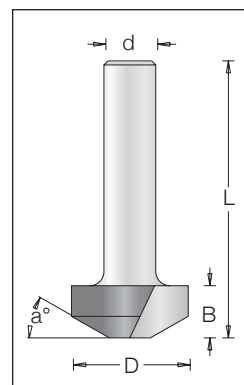

øD	a	B	Code No.	L	ød
28.6	30°	12.7	1290 01 9	69	12

⚠ Can be supplied with 1/2" shank.

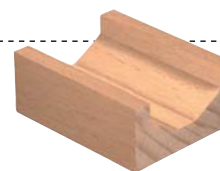

CNC

Raised Panel Bit

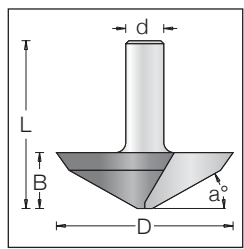

øD	a	B	Code No.	L	ød	n
67.7	25°	19.1	1291 07 9	67	12	18,000

Max. RPM

⚠ Can be supplied with 1/2" shank.

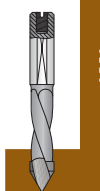
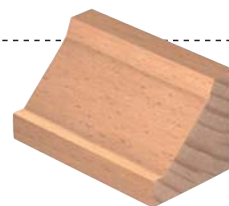

Drilling



Routing

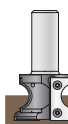

Custom Tooling

Routing

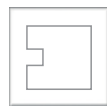

Grooving & Sizing



Profiling & Chamfering

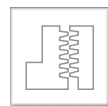

Jointing & Rebating

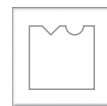

Carving



Corian



Raised Panel Bit

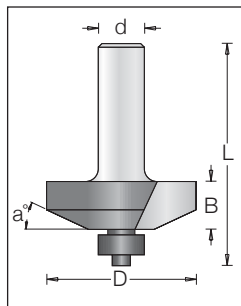

øD	a	B	Code No.	L	ød
41.3	25°	12.7	1230 01 9	62	12

⚠ Can be supplied with 1/2" shank.

Spare Parts:



Ball Bearing
#191 007 0
12.7x4.7x5

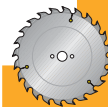
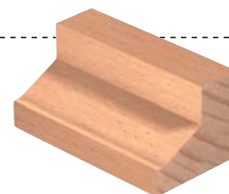

Sawing

Raised Panel Bit

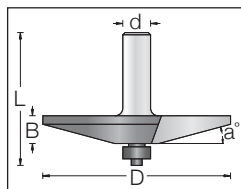

øD	a	B	Code No.	L	ød	n
85.8	15°	12.7	1221 04 9	71	12	16,000

⚠ Can be supplied with 1/2" shank.

⚙ Max. RPM

Spare Parts:



Ball Bearing
#191 007 0
12.7x4.7x5

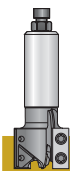
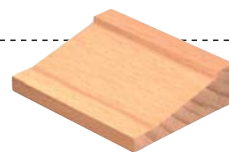

CNC

Raised Panel Bit

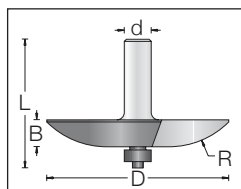

øD	R	B	Code No.	L	ød	n
85.8	40	12.7	1222 07 9	71.5	12	16,000

⚠ Can be supplied with 1/2" shank.

⚙ Max. RPM

Spare Parts:



Ball Bearing
#191 007 0
12.7x4.7x5

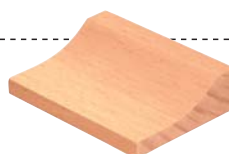

Cutting

Raised Panel Bit

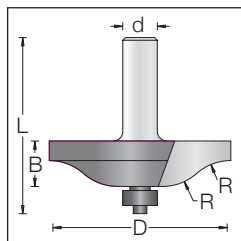

øD	R	B	Code No.	L	ød	n
66.6	19	17.0	1220 01 9	76.1	12	
85.7	22	15.9	1220 12 9	75.0	12	16,000

⚠ Can be supplied with 1/2" shank.

⚙ Max. RPM

Spare Parts:



Ball Bearing
#191 007 0
12.7x4.7x5

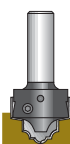
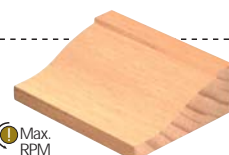

Routing

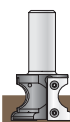

Custom Tooling



Routing



Grooving & Sizing



Profiling & Chamfering

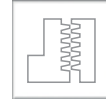

Jointing & Rebating



Carving

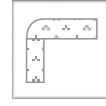

Corian

Raised Panel Bit

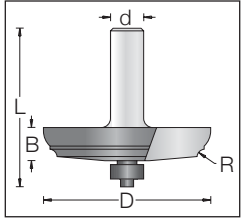

øD	R	B	Code No.	L	ød
63.5	3	12.7	1223 11 9	72	12

⚠ Can be supplied with 1/2" shank.

Spare Parts:



Ball Bearing
#191 007 0
12.7x4.7x5

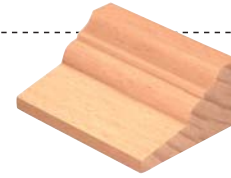

Raised Panel Bit

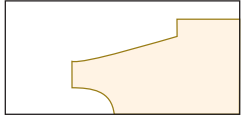
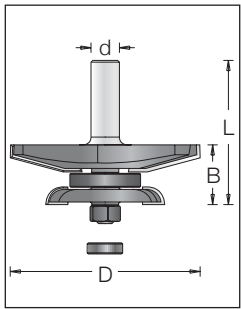

	øD	a	R	Code No.	B	L	ød	n
Complete	85.8			122 904 9	27.5	83.4	12	12,000
Profile cutter	85.8	15.0		122 504 9	12.7	83.4	12	
Cutter	54.0		7.9	122 501 0	7.9			

⚠ Can be supplied with 1/2" shank.

Max. RPM

Spare Parts:



Ball Bearing
#191 024 0
16x8x5



Ball Bearing
#191 971 0
31.7x8x6.2



Spacer
#192 018 0
1x12



Spacer
#192 013 5
0.5x12



Spacer
#192 120 0
0.05x12



Spacer
#192 115 0
0.1x12

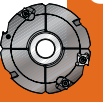
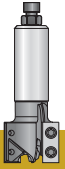

Raised Panel Bit

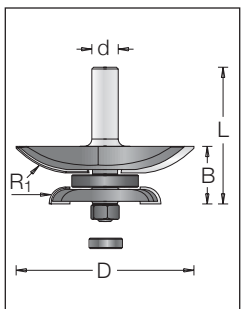

	øD	R	R1	Code No.	B	L	ød	n
Complete	85.8			122 907 9	27.5	83.4	12	12,000
Profile cutter	85.8	40.0		122 507 9	12.7	83.4	12	
Cutter	54.0		7.9	122 501 0	7.9			

⚠ Can be supplied with 1/2" shank.

Max. RPM

Spare Parts:



Ball Bearing
#191 024 0
16x8x5



Ball Bearing
#191 971 0
31.7x8x6.2



Spacer
#192 018 0
1x12



Spacer
#192 013 5
0.5x12



Spacer
#192 120 0
0.05x12



Spacer
#192 115 0
0.1x12

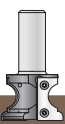
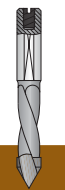
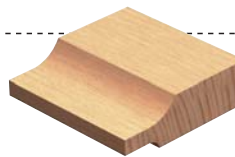

Routing



Grooving & Sizing



Profiling & Chamfering

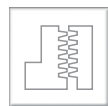

Jointing & Rebating



Carving

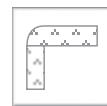

Corian



Raised Panel Bit

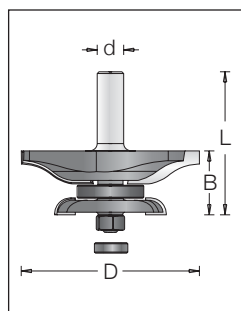

	øD	B	Code No.	L	ød	n
Complete	85.8	30.7	122 912 9	87.1	12	12,000
Profile cutter	85.8	15.9	122 512 9	87.1	12	
Cutter	54.0	7.9	122 501 0			

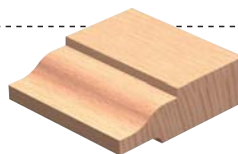

⚠ Can be supplied with 1/2" shank.

Max. RPM

Spare Parts:



Ball Bearing
#191 024 0
16x8x5



Ball Bearing
#191 971 0
31.7x8x6.2



Spacer
#192 018 0
1x12



Spacer
#192 013 5
0.5x12



Spacer
#192 120 0
0.05x12



Spacer
#192 115 0
0.1x12



Vertical Paneling Bit

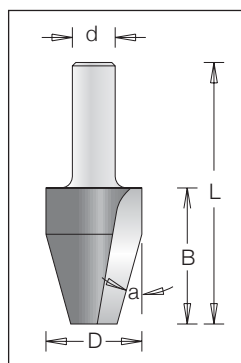

øD	B	Code No.	a	L	ød
28.6	41.3	1224099	15	79.3	12

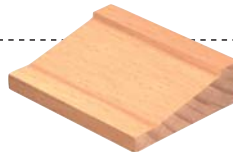

⚠ Can be supplied with 1/2" shank.

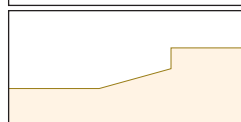

Vertical Paneling Bit

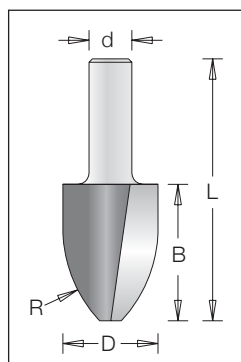

øD	B	Code No.	R	L	ød
28.6	41.3	1224079	40	79.3	12

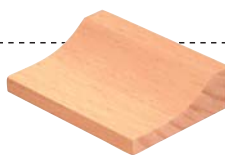

⚠ Can be supplied with 1/2" shank.

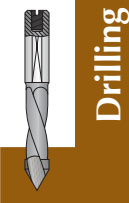
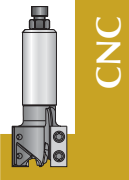
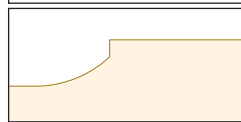



Routing



Grooving & Sizing



Profiling & Chamfering

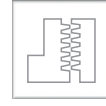

Jointing & Rebating



Carving

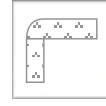

Corian

Index

Vertical Paneling Bit

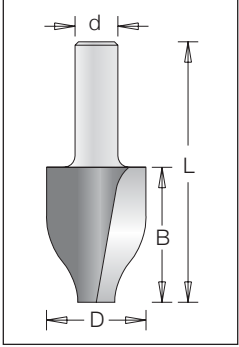

$\varnothing D$	B	Code No.	L	$\varnothing d$
30	41.3	1224089	79.3	12

⚠ Can be supplied with 1/2" shank.

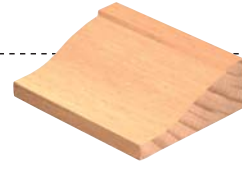

Sawing

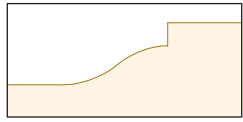

CNC

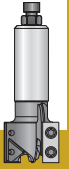

Vertical Paneling Bit

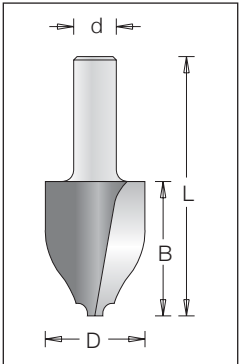

$\varnothing D$	B	Code No.	L	$\varnothing d$
30	41.3	1224059	79.3	12

⚠ Can be supplied with 1/2" shank.

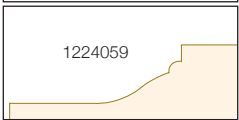

Cutting

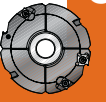

Drilling

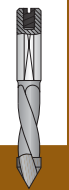

Routing

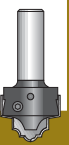

Custom Tooling

