

Drilling

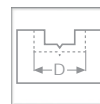

CNC &
Automatic
Machines



Multi
Purpose
Boring



Slot
Mortising

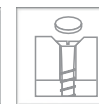

Counter
Sinking &
Plug maker

2022 - Countersink for Dowel Drills

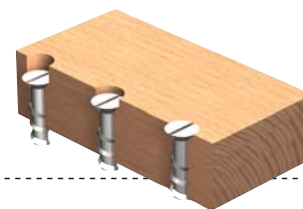
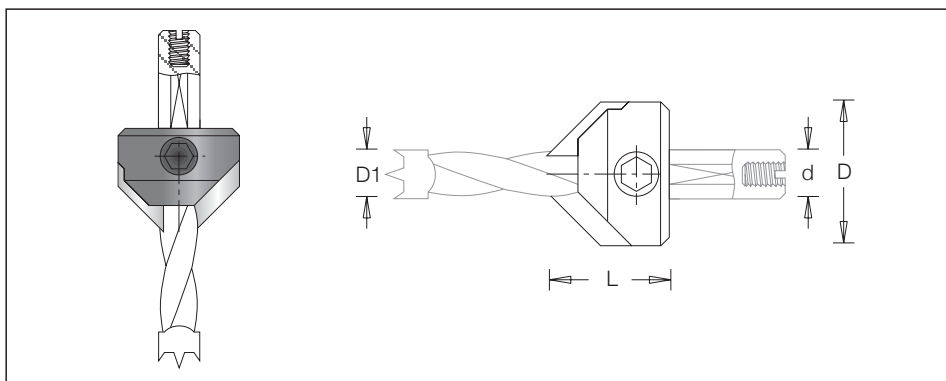

øD1	øD	Code No.		L	ød
		Right	Left		
4	15.6	202 202 0	202 203 0	17.5	10
5	16.0	202 200 0	202 201 0	17.5	10
6	16.0	202 204 0	202 205 0	17.5	10
7	16.0	202 206 0	202 207 0	17.5	10
8	18.0	202 210 0	202 211 0	17.5	10
9	18.0	202 214 0	202 215 0	17.5	10
10	20.0	202 220 0	202 221 0	17.5	10
12	20.0	202 224 0	202 225 0	18.0	10
5-10	15.5	202 226 0 *	202 227 0 *	16.5	10
5-10	20.0	202 230 0 *	202 231 0 *	17.5	10

 * This countersink is assembled on the shank of the drill.
Series of countersinks suitable for dowel drills.



Screw
#193 682 0
M6x10

Reduction Bushing for Combi Chuck

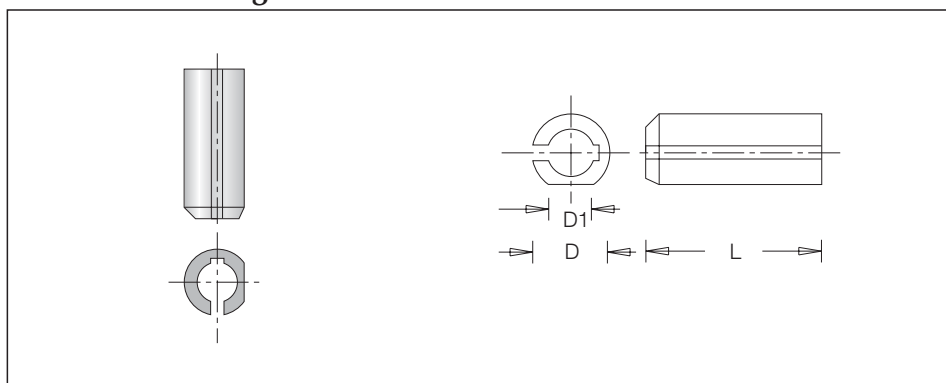

øD1	øD	Code No.	L
2.0	10	192 456 0	23
2.5	10	192 457 0	23
3.0	10	192 451 0	23
3.2	10	192 458 0	23
3.5	10	192 452 0	23
4.0	10	192 453 0	23
5.0	10	192 454 0	23
6.0	10	192 460 0	23
7.0	10	192 461 0	23
8.0	10	192 455 0	23

 To use with solid HM or HSS Drills.
Adapts to combi chuck with two tightening screws.

Index

Sawing

CNC

Cutting

Drilling

Routing

Custom Tooling