

# Sawing

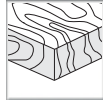

Solid Wood

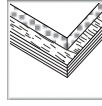

Boards



Plastic

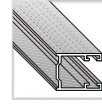

Aluminium

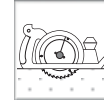

Saw blade for  
Portable  
Machines

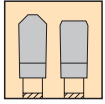

## MUP - Plastic Trimming & Sizing Saw Blade

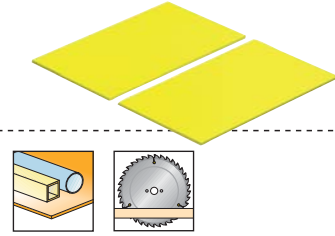
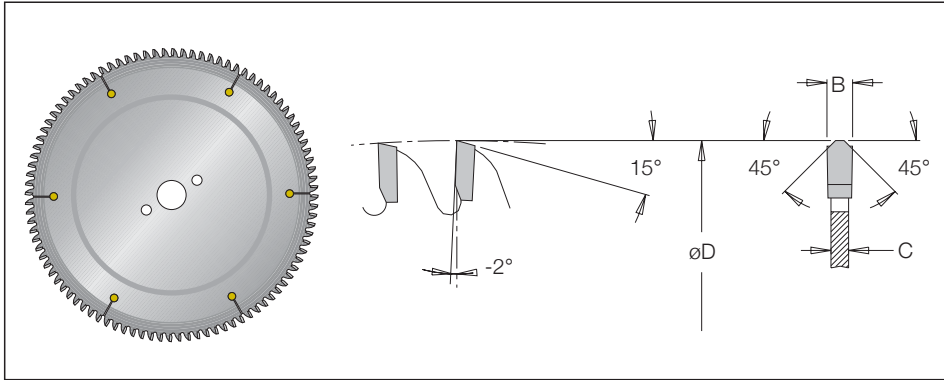

øD	Teeth	Code No.	B	c	ød
250	80	901 07 03 6	2.5	1.8	30
300	96	901 07 06 6	3.3	2.6	30
350	108	901 07 09 6	3.7	3	30

Manufacturing Technology:



Dynamic  
Straightness

Index

Sawing

CNC

Cutting

Drilling

Routing

Custom Tooling